



**Model 4000/6000
ENGINE INFORMATION SYSTEM
User's Manual**



**Grand Rapids Technologies Incorporated
3133 Madison Ave SE
Grand Rapids, MI 49548
(616) 245-7700 Fax (616) 245-7707**

Rev M
Applicable to Software Versions 7.5 and above.

Software Version _____

Serial Number _____

Model Number _____

Options _____

1. READ THIS FIRST!	5
2. AN OVERVIEW OF INSTALLATION & SETUP	5
3. USING THE ENGINE INFORMATION SYSTEM	6
3.1 THE BASICS OF THE ENGINE INFORMATION SYSTEM OPERATION.....	6
3.2 BEFORE EACH FLIGHT.....	6
4. SET PAGES – SETTING ENGINE LIMITS AND OTHER USER ENTRIES	7
4.1 SET PAGE TABLE OF LIMITS.....	8
5. INSTALLATION	10
5.1 MOUNTING THE INSTRUMENT – POSITION AND OTHER CONSIDERATIONS	10
5.2 WIRING	11
5.2.1 <i>Outside Air Temperature Sensor</i>	12
5.2.2 <i>Water Coolant/Oil Temperature Sensor</i>	12
5.2.3 <i>Voltmeter</i>	12
5.2.4 <i>Oil Pressure Sender</i>	12
5.2.5 <i>Magnetic Tachometer Sensor</i>	12
5.2.6 <i>External Alarm Output</i>	13
5.2.7 <i>Auxiliary Inputs</i>	13
5.2.8 <i>Cylinder Head Temperature Probe Installation</i>	13
5.2.9 <i>Exhaust Gas Temperature Probe Installation</i>	13
5.2.10 <i>Carburetor Temperature Probe</i>	14
5.2.11 <i>EGT & CHT Extension Wire</i>	14
5.3 VERIFY THE WIRING – A QUICK CHECK.....	15
6. CHECK-OUT	15
6.1 INITIAL APPLICATION OF POWER TO THE INSTRUMENT	15
6.2 TACHOMETER INITIAL TEST	15
6.2.1 <i>Testing Tachometer Inputs</i>	15
6.2.2 <i>Testing Tachometer Accuracy</i>	16
6.3 OTHER CHECKS.....	16
7. CONFIGURING THE EIS FOR YOUR AIRPLANE	16
7.1 SETTING UP YOUR AUXILIARY INPUTS – LABELS AND SCALING.....	17
7.1.1 <i>Aux1, Aux2, Aux3, Aux4, Aux5, Aux6</i>	17
7.1.2 <i>Dual TIT Option and Aux5/Aux6</i>	17
7.1.3 <i>Auxiliary Scale Factors and Offsets (1SF, 1OFF, 2SF, 2OFF...)</i>	17
7.1.4 <i>Configuring an Auxiliary Input for a Fluid Temperature Sensor</i>	18
7.1.5 <i>Auxiliary Forward/Reverse Sensing Selection (+/-)</i>	18
7.1.6 <i>Auxiliary Decimal/Integer Selection (D/I)</i>	18
7.1.7 <i>Transfer function</i>	19
7.2 UNITS – (FAHRENHEIT/CELSIUS AND GALLONS/LITERS)	19
7.3 FC1 & FC2 (FUEL FLOW ACTIVATION CODES)	19
7.4 FLOCAL (FUEL FLOW CALIBRATION)	19
7.5 FLOCALR (RETURN FUEL FLOW CALIBRATION).....	20
7.6 TACHP/R - SETTING FOR CORRECT TACHOMETER READINGS.....	20
7.6.1 <i>Tach Connections to Magneto P-leads, Ignition Coils or Tach Outputs</i>	20

7.6.2	<i>Tach Connections to Lighting Coils (Jabiru, Rotax, and others)</i>	21
7.6.3	<i>Rotax 912 Engine</i>	21
7.6.4	<i>TachP/R Table</i>	21
7.7	TACHSEN	22
7.8	PEAK – LEANING FUNCTION SENSITIVITY ADJUSTMENT	22
7.9	MAX FUEL – (FUEL CAPACITY ENTRY FOR FUEL FLOW OPTION).....	22
7.10	HOURS (SETTING HOURMETER)	22
7.11	TIM-RPM (HOURMETER & FLIGHT TIMER RPM THRESHOLD)	22
7.12	ASPDLO, ASPDHI, TACHLO, TACHHI (LANDING CHECKLIST REMINDER/RPM RANGE LIMIT)	22
7.12.1	<i>Landing Checklist Reminder</i>	22
7.12.2	<i>RPM Range Limit</i>	23
7.13	ALTCOR (CALIBRATING THE ALTIMETER/BAROMETRIC PRESSURE)	24
7.14	ALTSF, 1 (10K), 2 (20K), 3 (30K), 4 (40K) ALTIMETER ADJUSTMENTS (SW VERSION 5.8 AND ABOVE).....	24
7.14.1	<i>Precision Altimeter Calibration Procedure</i>	24
7.15	USER DEFINABLE COMBINATION PAGES	24
7.15.1	<i>ID1, IP1, ... GD9, GP9</i>	24
7.15.2	<i>Table of User-Definable Page Entries</i>	25
7.16	EXAMPLE WORKSHEET FOR SETTING UP YOUR CUSTOM PAGES	28
7.17	WORKSHEET FOR PLANNING USER-DEFINABLE PAGES	29
8.	DISABLING PAGES	31
9.	ENGINE ANALYSIS FUNCTIONS	31
9.1	THE EGT TRACKING FUNCTION	31
9.2	LEANING FUNCTIONS	32
9.2.1	<i>Leaning with the Bar Graph</i>	32
9.2.2	<i>Digital Leaning Page</i>	32
9.2.3	<i>Special leaning functions</i>	33
9.2.4	<i>First-Cylinder-to-Peak (FRST2PK)</i>	33
9.2.5	<i>EGPk (First-Cylinder-to-Peak Leaning Status)</i>	33
9.3	SHOCK COOLING DETECTION	33
10.	DETAILED DESCRIPTION OF OTHER FUNCTIONS	34
10.1	FLIGHT TIMER	34
10.2	UNIT TEMPERATURE	34
10.3	H2O (WATER TEMPERATURE FUNCTION)	34
11.	UPDATING THE EIS SOFTWARE	34
12.	CHECK ENTRIES MESSAGE	34
13.	TROUBLESHOOTING COMMON PROBLEMS	35
14.	WARRANTY	36
15.	FIGURES	36

Revision L Changes

Updated Jabiru Tach P/R settings (Section 7.6.4)

Congratulations on your purchase of Grand Rapids Technologies' Engine Information System (EIS). We are pleased that you have chosen our product to meet your aircraft instrumentation needs. You will find this system will enhance your flying pleasure while increasing your level of safety.

1. Read This First!

Note for those upgrading the software with a new computer chip. After installing the chip, it may be initialized to factory default settings by pressing and holding the right button when turning the instrument on. After a delay of a few seconds, this will set the user-defined pages to the factory configuration.

Advice Before Starting Your Installation: Three steps to make your installation easier.

Step 1. Determine how you would like to arrange your EGT/CHT connections. The EGT/CHT inputs are numbered 1-4 (1-6 for the Model 6000). You may simply connect EGT1 & CHT1 to cylinder number one (according to the engine manufacturer's cylinder numbering). This is common, and works well. For four-cylinder engines there is also an alternate method. You may wish to connect the EGTs and CHTs so they correspond to their position on the digital display pages. That is, connecting EGT 1 & CHT 1 to the front left cylinder (since it appear on the top left position of display page), EGT 2 & CHT 2 to the front right cylinder (since it appears on the top right position of the display page), and so on. (Figure 1 illustrates the position of the data on the display pages.) Either option works well, although personally the latter method is easiest. The main point is to make sure you know which cylinder corresponds to each of the readings on the instrument so that you will perform maintenance on the correct cylinder when it becomes necessary.

Step 2. Plan which functions you will wire to each of the 4 auxiliary inputs. Recall that manifold pressure, fuel pressure, fuel level, vacuum, coolant pressure (and any others that do not have a dedicated input to the instrument) must be connected through the auxiliary inputs. (The auxiliary inputs may be used for other functions also, but these are the most common uses.) The only significant consideration concerns the position of the auxiliary input functions on the labeled pages. Referring to figure 1b, you will note that auxiliary 1, 2, & 3 appear on page 12, and auxiliary 4 appears on the next page. You may prefer to see two or three auxiliary functions on the same page (for example, left and right fuel levels). This will require wiring them to the first three auxiliary inputs.

Step 3. Remember that you have complete control over what will be displayed on the two combination pages, and the digital data displayed on the bar graph pages. You will find this useful for conveniently displaying the exact data you would like available during your flight

...now on to the installation!

2. An Overview of Installation & Setup

Installation of the EIS includes the physical mounting of the instrument into the airplane's instrument panel, making the electrical connections from the pre-wired cables to the various sensors, and finally setting entries in the instrument to customize your instrument for your installation. The first two steps are quite obvious. The entries made to the instrument for your installation tells the instrument such things as how many pulses per revolution of your engine, units (Fahrenheit or Celsius), etc.

Following these steps, operation of the instrument will be verified by applying power to it. Finally, you will set your engine limits, and customize the display pages to your liking.

During flight you will use the leaning functions to accurately lean your engine. During the cruise portion of your flight you will use the tracking functions to continuously monitor your engine for even momentary signs of developing engine problems. Now let's get started with the installation by turning to the section "Installation" which begins on page 10

3. Using the Engine Information System

Refer to figure 1 for a description of the various display pages, and to figure 2 for an illustration of the use of the EIS from panel keys to control the operation of the instrument.

3.1 The Basics of the Engine Information System Operation

- **Power to EIS when starting the engine.** It is good practice to turn on the EIS before starting the engine, and verify a low oil pressure warning is generated. This verifies the oil pressure sensor is able to sense zero pressure correctly. The instrument may be left on, and the engine started, at which time the warning light should go off, indicating oil pressure is within limits. While the oil pressure sensor is very reliable, this procedure is recommended because it requires little more than turning the instrument on before starting your engine.
- **The Display button and your favorite page.** Double-clicking the "Display" key will immediately change screens to the page you have selected as your favorite display page. This provides a quick and simple means of returning your instrument to your favorite page, after you have been reviewing other display pages. To make your selection of which page is to be displayed by the "Display" key, see the "Set Pages" section.
- **The Display button and On-Screen Labels.** Pressing and holding the "Display" button while on a user-configurable page (a combination page or bar-graph page) will replace the numeric data with labels, making it easy to identify the data on the screen. Releasing the button returns the display to numeric data.
- **The Alarms – The most important part!** The instrument's alarm function will alert you to out-of-limit conditions by flashing the warning light (to get your attention), and simultaneously changing pages to a labeled screen and flashing the reading above its label to identify it. If the problem can not be fixed immediately, the alarm should be acknowledged by pressing the "Next/Ack" button on the EIS. (When the alarm light is flashing, the instrument will ignore the other buttons.) Acknowledging an alarm returns the instrument to the page it was previously on, and allows it to alert you to the next problem. After acknowledging an alarm, the warning light will remain continuously on as long as any out-of-limit condition exists. The warning light will go out when everything is within limits. An alarm that goes away, and then returns, is treated as a new warning, and will again generate the response described here. Multiple alarms are presented according to priority, one at a time.
- **Determining Alarm Status** – After acknowledging one or more alarms, the warning light will stay continuously on indicating as long as one or more functions are out-of-limits. To make the instrument to show you the current out-of-limit conditions, select the "Set Pages", then simply hold the right button depressed until the instrument returns to the normal display pages. Upon leaving the set pages, the instrument will clear the acknowledgement of all alarms, causing it to re-annunciate all current alarm conditions as if they were new alarms. Turning the power of and back on will also accomplish this action, but will reset the flight timer.
- **Set Unused Limits to Zero.** By setting a limit to zero, the alarm function for that limit will be turned off. It is a good idea to set limits for all unused functions to zero so that the instrument does not inadvertently generate nuisance warnings for signals you are not using.

3.2 Before Each Flight

1. If the instrument includes the altimeter option, set it before each flight.
2. If the instrument includes the fuel flow option, review or update the fuel quantity setting as necessary. (Pressing the outer two buttons of the EIS will bring up the fuel quantity set page. While on this page, pressing the "UP" and

"DOWN" (left and center buttons) will set the fuel quantity to whatever you have entered on the "MAX Fuel" setting on the configuration set pages.)

All engine limits are stored with a checksum. If the instrument determines a user setting has been lost, it will generate a "Check Entries" message at power-up. If you see this message, carefully review all user settings.

At power-up, the EIS will automatically select the page you have set as your favorite in the "DISPLAY" set page. If an alarm is active, the instrument will first annunciate the alarms (requiring you to press the right button to acknowledge them) before going to your favorite page.

Suggestion! Include in your checklist a step to turn on the instrument before starting the engine. Verify you get a low oil pressure warning (and possibly others). This is a simple way of verifying the oil pressure sensor is correctly measuring zero oil pressure. This is recommended not because the sensor is prone to failure (it is actually very reliable), but because it is a very easy test to verify the most critical engine monitoring function.

NOTE: It is possible for the instrument or its sensors to suffer various kinds of failures that can not be detected by the self-test. It is good practice to review the various display pages periodically as necessary to verify that the instrument and its sensors are operating normally.

4. SET PAGES – Setting Engine Limits and other User Entries

The "Set" pages are used to enter engine limits and other selections into the EIS. These pages are accessed by simultaneously pressing the two keys marked "SET LIMITS", as illustrated in figure 2. The use of the engine limits, and the other features controlled on these pages, are described below. All entries on these pages are retained when the instrument is turned off. No electrical connection to the instrument, or battery is required to maintain these settings.

Since all limits can be entered easily by the pilot at any time, it is practical to set engine limits lower than those indicated by the engine manufacturer, but slightly higher than encountered in normal operation. In this way, a change in normal engine operation may be detected earlier.

Minimum and maximum limits are included for most functions, even when some of the limits may have no everyday practical use. This allows additional flexibility to assist with engine troubleshooting, especially to help alert you to intermittent problems that would otherwise be hard to detect.

All limits must be set in the same units selected on the "UNITS" page. If you change the units (from Fahrenheit to Celsius for example), the limits will not change, making all temperature limits incorrect unless reset to Celsius.

NOTE: Limits that are not used should be set to zero. This disables the limit to prevent nuisance false warnings. Some limits may not have a practical use for routine flying, but have been included to provide additional flexibility in diagnosing engine problems. Normally these limits are set to zero.

CAUTION: While the "Set" pages are selected, the automatic warning feature of the instrument is disabled. This is necessary to allow the pilot the ability to change an engine limit in the presence of an engine parameter that is intermittently outside of its limit. The warning light is illuminated while the "Set Limits" pages are selected to remind you that the warning feature has been disabled--and as a convenient means of testing this light.

All alarms will be annunciated as described in "Using the Engine Information System", unless otherwise noted in the table below.

4.1 Set Page Table of Limits.

Setting	Use	Recommended Setting
Cont	Contrast - Adjusts screen for maximum readability based on viewing angle and instrument temperature. *See end of table for more information about this setting.	2 or 3
Back_Light	Sets the intensity of the backlight. Lower settings correspond to lower intensity, with zero corresponding to backlight off.	Set this to maximum level acceptable for night flying.
Alt	Altimeter - Adjusts altimeter to account for current barometric pressure. Note that the barometric setting is displayed directly below the "Baro" label, and altitude below the "Alt" label.	Set to airport's elevation or current altimeter setting.
Fuel	Fuel quantity calculated by the fuel flow function. After adding fuel to the airplane, set this to match the quantity in the airplane. Note: Pressing "Next" and "Display" buttons together jumps you directly to this page from a normal display page. Pressing the left and center button together while on this page sets the fuel quantity to the Max Fuel entry.	Set to match amount of fuel in the airplane. Not applicable if the fuel flow option is not installed.
Max Time	Alerts pilot when flight time exceeds this limit. Useful as a warning to check fuel. Limit is entered in minutes, so 2 hours is entered as 120, etc.	30-45 minutes less than airplane's endurance.
Interval	Provides a warning that repeats at the interval entered in minutes. Useful as a reminder to perform periodic tasks such as switching fuel tanks. Acknowledging this alarm cancels the warning completely, therefore the warning light will not remain on after acknowledging this alarm.	As required. Typically 30-60 minutes is used for changing fuel tank selection.
Max Flow	Maximum Fuel Flow – Generates a warning when the fuel flow (rate of fuel burn) exceeds this limit. Useful for detecting badly leaking fuel lines, loose connections to fuel injectors, etc. Very useful safety feature for all engines, but especially fuel injected engines. Be sure to use it!	Set about 10-20% above max fuel flow rate at full takeoff power. Applicable only if the fuel flow option is installed.
Max OilP	Maximum Oil Pressure. Useful as a reminder to reduce RPM when warming a cold engine, especially in winter conditions, to avoid excessive oil pressure.	98 or less. Max oil pressure displayed by the instrument is 99 psi.
Min OilP	Minimum Oil Pressure – Essential! Be sure to use this one! Warns of loss of oil pressure. As this is the most serious alarm, some pilots may take drastic action when seeing this alarm. Consider you situation carefully if you get this alarm. An instrumentation failure (sensor failure) is possible, as is complete engine stoppage or anything in between. Use your judgement!	As recommended by the engine manufacturer, or 20 psi.
Min Crz_OP	Minimum Cruise Oil Pressure - Generates a warning when the oil pressure is below this limit. This limit is active only when the engine RPM is above the min Lim-RPM setting. This allows setting a low oil pressure limit that apply only at higher engine RPM.	As recommended by engine manufacturer, if available. If not provided, set based on experience.
Max OilT	Maximum Oil Temperature	As recommended by engine manufacturer.
Min OilT	Minimum Oil Temperature – Intended for troubleshooting engine problems. Also useful as an "engine not warmed up yet" reminder.	Set limit based on experience.
Max RPM	Warns when engine exceeds maximum RPM	Set according to engine

		manufacturer's recommendation.
Min RPM	Warns when engine RPM falls below this entry. Useful for troubleshooting engine problems. May also be used as a warning that the engine RPM is dropping too low on the landing rollout which could result in engine stall.	Set limit based on experience.
Min Fuel	Minimum Fuel Quantity – Generates a warning when the fuel flow function's fuel quantity drops below this limit.	Set to at least enough useable fuel to provide 30-60 minutes of fuel at cruise power. Applicable only if the fuel flow option is installed.
Min Aux (1-6) Max Aux (1-6)	Minimum & Maximum for Aux input.	Set limit as needed depending on the use of the auxiliary input. Some uses of the auxiliary inputs do not require limits (such as manifold pressure) and some do, such as fuel pressure.
Max H2O	Maximum water temperature limit	Set limit as recommended by engine manufacturer
Min H2O	Minimum water temperature limit. Intended for troubleshooting engine problems. Also useful as an "engine not warmed up yet" reminder.	Set limit based on experience.
Max Volt	Maximum Voltage Limit – Allows for detection of failed regulator. Loss of correct voltage regulation resulting in over-charging (and subsequent high voltage) will greatly shorten the life of the battery, and could be dangerous.	Start with 15.6 volts. Lower as much as possible without getting false alarms. Typical limit should be 14.6 Volts.
Min Volt	Minimum Voltage Limit – Allows for detection of loss of charging. This limit is only tested when the engine RPM is greater than the EGT-RPM setting. This prevents false alarms on final approach (low RPM) with landing lights on.	Set limit to about 12.8 volts to get immediate alerting of loss of charging, although this will cause low voltage alarm whenever instrument is on while engine is not running. Set to 12.4 volts or less to avoid alarm when engine not running, but still gives alarm shortly after battery discharging has begun.
Max Carb	Carb temp warning is generated when the carb temp falls between the Max Carb and Min Carb Limit.	40-60 deg F
Min Carb	See Max Carb	0-20 deg F
Max EGT	Maximum EGT – Not all engines have published limits, nor do all engines require a maximum EGT limit. This alarm can be useful for troubleshooting engine problems also.	Set limit according to engine manufacturer recommendation, or based on experience.
Min EGT	Minimum EGT – This alarm is active only when the engine RPM is above the entry for EGT-RPM. This alarm is useful to detecting the loss of a cylinder, or for troubleshooting engine problems.	800-1200 deg F, depending on sensitivity desired. If false alarms are consistently generated, reduce the limit to less than 800 deg F, or set to 0.
Lim-RPM	Defines the RPM at which the following RPM dependant limits become active. These are: Min EGT, Min Volt, Min Crz_OP	Set limit to an RPM slightly less than the RPM used for the MAG check. This allows the Min Volt test to become active during the MAG test to automatically test for charging.
Max EgtSpan	Maximum difference between the highest and lowest EGT. This limit can be used to help detect changes in normal engine	Set this limit based on experience. It may take some trial and error to

	operation. It is also useful when leaning using the digital leaning pages, as it is possible to not notice a EGT that is abnormally low when using these pages to lean the engine. (Its more obvious on the bar graph pages.)	arrive at a good limit. After establishing a limit that rarely generates alarms, activation of this alarm may indicate developing engine problem.
Max EGT-Inc	Maximum Increase in EGT from the Lean Point. This alarm is active while lean point is active. This alarm will often generate a false alarm when the load on the engine significantly reduced during descent. To avoid this false alarm, reset the Lean Point. (Selecting “Set Lean Page” and “Yes” activates alarm; “Reset” de-activates alarm.)	Set limit based on experience. A small value will allow sensitive detection of EGT increases, which is useful for detection of intermittent problems. Normal operation may require a larger setting to prevent false alarms due to normal EGT fluctuation caused by turbulence or other small power/load fluctuations.
Max EGT-Dec	Maximum Decrease in EGT from the Lean Point. See also Max EGT-Inc description.	Set limit based on experience. You may find that this limit is significantly different from the Max EGT-Inc. See also Max EGT-Inc description.
Max CRate	Maximum Cooling Rate for CHT – The alarm is provided in degrees/minute, and corresponds to the maximum rate of decrease in CHT. No limit applies to the maximum rate of increase. All cylinders are checked for this limit.	Set limit based on engine manufacturer’s recommendation. If no limit is provided, establish a limit based on experience.
Max CHT	Maximum Cylinder Head Temperature. Often engines will normally operate significantly lower than the engine manufacturer’s limit. Consider setting this limit lower than the maximum to get early warning of abnormal CHTs.	Set according to engine manufacturer’s recommendation.
Min CHT	Minimum Cylinder Head Temperature. Intended for engine troubleshooting problems. Also useful as an “engine not warmed up yet” reminder.	Set limit based on experience or to zero if not used.
Display	Define which page number is your favorite. The instrument will select this page at power-up, or when leaving the set pages, after all alarms (if any) are acknowledged. This page is also selected by double clicking the “Display” button. See figure 2 for page numbering. This is a very useful feature. Be sure to use it!	Set the your favorite page number.

***Contrast** – The contrast of the LCD display is set on this page. Four levels of contrast may be selected, 0-3, with the lower settings best for higher ambient temperatures, and the higher settings best for normal and cooler temperatures. Make your selection to achieve the most desirable appearance of the display. It may be necessary to change it in response to large ambient temperature changes, although this is rare. The contrast setting will automatically reset to level 2 at power-up if it is set below level 2.

5. INSTALLATION

5.1 Mounting the Instrument – Position and other considerations

The first step in mounting the instrument is selection of a suitable location in the aircraft. The location must be selected such that it is not exposed to water or fuel, and preferably away from other devices that generate heat. The instrument does not generate electrical noise that will interfere with radios, nor is it affected by transmissions from radios or engine ignition systems. It is not likely to affect a magnetic compass.

The excellent readability making in non-critical as to where the instrument is mounted with respect to the pilots eyes. The instrument uses an anti-glare window to minimize reflections. Of course the instrument should be positioned to allow easy access to its front panel buttons.

The instrument should be secured using the mounting holes in the faceplate. Figure 4 provides the physical dimensions of the instrument and a full-size mounting template. If the mounting template is used, its dimensions should be verified, as paper may expand and contract with humidity.

NOTE: No special consideration must be given regarding protection from vibration. The mechanical design of the instrument is very rugged. This is of course not true of other instruments, especially mechanical airspeed indicators and altimeters. The instrument does not emit electrical noise that will interfere with any radios, and can be mounted next to a radio without concern. A magnetic compass may also be located next to the instrument if desired, with no measurable effect, on or off.

5.2 Wiring

Figure 5a & 5b illustrates all electrical connections made to the EIS. The “Detailed Wiring Description” below provides additional information about wiring the instrument into your aircraft. Review this material to familiarize yourself before proceeding further.

Using this figure, start the wiring process by carefully planning and **DRAWING A WIRING DIAGRAM** for your aircraft. The wiring diagram is essential in planning a successful installation. Install the wiring, routing all wires required by the EIS to its planned location. A high-quality 22-gauge stranded wire, 7 or 19 strands, is recommended for all connections other than those made to the CHT and EGT probes. Solid conductor wiring is not acceptable. Thermocouple extension wire must be used for the CHT and EGT probes to prevent the introduction of errors into these measurements.

CAUTION: Use a separate ground wires for the ignition kill switches and the remainder of the electrical system if possible. These separate ground wires should attach to different places on the case of the engine so that both sets of grounds could not disconnect from the engine while remaining connected to each other. This provides additional protection for the instrument (although its internal protection is usually more than adequate), but more importantly, protects other electronic equipment in your airplane from potential damage. See the sheet at the back of the manual for more information.

All electrical connections are made to the EIS via two 25-pin sub-D type connectors. Pre-wired, color-coded cables are supplied with the instrument.

1. Start by making the power and tachometer connections as illustrated in figure 7. Note that 10.5-20 Volts DC, 0.20 Amperes is required to power the instrument. The instrument includes an internal thermally activated fuse that protects the instrument. A fuse should be used in the aircraft wiring so that a short in the wiring external to the instrument does not cause an electrical fire. Typically a fuse up to 5 amps may be used for this purpose, depending on the wire gauge and lengths. This fuse may be shared with other items, such as radios and such.
2. For proper operation of the instrument, the ground (black wire) from the instrument must be connected to the case of the engine. Since most engines are grounded to allow operation of the electric starter, only the connection from the instrument to the negative (-) terminal of the battery must be considered. Ideally, the ground wire for the instrument should not be shared with other electrical devices. If other devices share the ground wire used by the instrument, use a digital voltmeter to verify the voltage difference between the case of the EIS, and the negative terminal of the battery is less than 20 mV with all electrical devices which share this ground wire turned on.

3. Do not use the same ground lead for the instrument, and the ignition kill switch(es). Be sure these separate ground leads do not connect to the engine in such a way that they could become disconnected from the engine, but remain connected together.
4. The remainder of the signals are now connected. Accuracy of these sensors is not affected by the length of the leads. Refer to figure 5a & 5b for an illustration of these connections.

5.2.1 Outside Air Temperature Sensor

The sensor for this unit is mounted using the plastic clip. This clip is attached to the airplane, and the sensor snaps into it. To assure maximum accuracy, do not install the sensor such that it is in the path of engine exhaust gases or cooling air outputs. Also avoid attaching it to aircraft structure that is warmed by the sun. The ideal location is under the wing, or under the fuselage for pusher-engine installations. It is very easy for the probe to get warmed by the engine if it is installed behind the engine, usually resulting in readings that are 5-10 deg F too high. Avoid routing the wires to this sensor near radios, ignition systems, or other electronic devices as much as practical. Ground the sensor near then instrument To help prevent electrical noise from affecting the sensor, twist the entire length of leads from the instrument to the OAT probe.

The outside air temperature is displayed in degrees Fahrenheit and Celsius as shown on figure 1.

5.2.2 Water Coolant/Oil Temperature Sensor

Start by installing the sensor in the engine according to the recommendations of the engine manufacturer. After installation, route the wires through engine compartment, making certain the wire is supported so that it will not be chaffed. A connector or terminal strip may be used between the aircraft wiring and the sensor to enhance maintainability if desired. Single-wire type sensors, (those which have a one electrical connection to them) require that their cases be connected to ground. For these sensors pipe thread compound should be used to seal the sensor. Teflon tape should be avoided because it may electrically insulate the case of the sensor from ground. If practical, connect the ground wire to the same point where the instrument is grounded to minimize differences in ground voltages.

5.2.3 Voltmeter

The voltmeter senses its voltage through the power input to the instrument, and thus does not require a separate connection.

5.2.4 Oil Pressure Sender

The oil pressure sender should first be installed on the engine. This sender uses an 1/8-27 NPT pipe thread fitting, but may be adapted to any engine with the appropriate pipe fitting adapters. The sender may also be mounted remotely, using suitable hose connections. This is necessary with some engines, especially Lycoming.

The electrical connections are made through the case of the sender (ground) and the electrical terminal opposite the pipe thread fitting. Ground is normally provided by the engine when the sensor is mounted directly to it, but a separate ground wire may be necessary for remote installations.

5.2.5 Magnetic Tachometer Sensor

See instructions with this sensor for installation recommendations.

5.2.6 External Alarm Output

This output is used to control the external warning light included. The output is an OPEN/GROUND type output. This means that when this output is off (the alarm is not active), this line is equivalent to an OPEN circuit. When this output is on, this output is switched to GROUND. Thus, the external warning light (or annunciator) is connected to this output and +12 Volts. The maximum current this output can control is 0.11 Amperes, or 110 mA. Exceeding 110 mA will normally cause this output to go to the open state, although it is possible to damage this output if the condition is not corrected.

5.2.7 Auxiliary Inputs

Your instrument includes 6 auxiliary inputs. Wire these inputs to your sensors for the auxiliary inputs according to the sheets included with the auxiliary input sensors. Refer to the “Advice Before Starting Your Installation” section at the front of this manual regarding assignment of the auxiliary inputs to the various functions.

If you are using the auxiliary input for your own custom application, this input must be in the range of 0-5 Volts DC, and must not exceed 5.5 Volts. The scaling of this auxiliary display number *n* is set using the “nSF” and “nOff” as described in the “Configuration Set Pages” section. If this input is not used, the Aux limit should be set to zero on the “Set Limits” pages to prevent nuisance warnings.

CAUTION: This input must not exceed 5.5 Volts. Although no damage will occur the accuracy of the instrument will be adversely affected while an aux input exceeds 6.0 Volts.

5.2.8 Cylinder Head Temperature Probe Installation

Ring-terminal type CHT probes are installed by removing the spark plug, placing the sensor under it, and re-installing the plug into the engine. Orient the sensor so that as much clearance as possible is provided between its leads and the engine structure.

Bayonet type CHT probes (for Lycoming and Continental engines) are retained by a bayonet adapter. This adapter is screwed into the engine, in a threaded hole near the bottom spark plug. This hole can be identified by its solid bottom. ***Do not use the primer hole to mount this adapter! If you are in doubt, consult an expert!*** The CHT probe is adjusted by turning the locking collar on the spring so that its tip is pressed against the bottom of the CHT probe well when it is locked onto the adapter.

NOTE: To prevent false readings for inputs that are not used, it is recommended that unused CHT inputs be shorted together. Unused EGT inputs may also be shorted together, or may be hooked up in parallel with another EGT input so that the EGT Span calculation remains meaningful.

5.2.9 Exhaust Gas Temperature Probe Installation

Start by drilling an 1/8-inch diameter holes at the appropriate position in the exhaust manifold as indicated by the engine manufacturer. If the manufacturer provides no guidance on the location of the EGT probes, we recommend the following:

1. Position the probe 2-8 inches from the cylinder.
2. Although not critical, it is preferable to position all probes the same distance from the cylinder.
3. If possible, position the probes so that they are mounted on a straight (not curving) portion of the exhaust manifold. The hose clamps fit slightly better on straight portions of the manifold.

4. Position the hole around the manifold so that the probe does not interfere with the cowl, and takes into consideration practical needs related to maintenance (does not interfere with the access to the oil filter, etc.), inspections, or probe mounting.

Insert the probe into the exhaust manifold and secure it by tightening the clamp firmly. Do not over-tighten.

CAUTION: Secure installation of the exhaust gas temperature sensor is critical to safe operation of your engine. Failure of this sensor to remain installed in the exhaust manifold could result in an exhaust leak of hot exhaust gases containing carbon monoxide. This poses a potential fire and/or cabin air-contamination threat. Inspection of the installation by a licensed A&P mechanic is recommended.

It may be necessary to safety wire the EGT probe such that it is impossible for the probe to come in contact with rotating engine parts or the propeller should its attachment fail. This is especially of concern with pusher-type engine installations.

It is necessary for this probe to be grounded. In most cases no special provisions are required to achieve this, since the exhaust manifold is normally connected to ground via the engine, and the EGT probe clamp typically makes a good electrical connection to the exhaust manifold. An ungrounded probe may cause erratic EGT readings.

5.2.10 Carburetor Temperature Probe

The carburetor temperature probe is mounted in the carburetor such that it senses the air temperature in the venturi. See the sheet that accompanies this probe for further details about its mounting.

5.2.11 EGT & CHT Extension Wire

All models of the EIS correct the EGT and CHT inputs (the thermocouple inputs) for the ambient temperature. This is called “cold-junction compensation”. To perform this compensation accurately, all models of the EIS, except those marked with the “Ext CJ” designation, or those using the temperature compensating terminal strip, require thermocouple extension wire.

Unlike other types of wire, thermocouple extension wire is polarized. Each conductor is made of a different alloy, and is identified by the color of the insulation. It is necessary to use matching extension wire for thermocouple probes, and to observe this polarity, for accurate readings. For example, the EIS requires type J thermocouple for sensing cylinder head temperature. To extend the leads of the cylinder head temperature probe, type J extension wire is required.

Extension wire type is identified by the color of the insulation on the two wires.

Type	Color of Insulation on the Wires	Use
J	Red and White	Cylinder Head Temperature
K	Red and Yellow	Exhaust Gas Temperature

Leave slack in the wire between the engine and airframe to account for engine motion. To avoid confusion, it is a good idea to label each wire to identify which cylinder it is to be used for.

Crimp the mating connectors onto the extension wire. Plug the color-coded leads onto the matching color extension wires. Secure the probe leads with suitable wire clamps to prevent them from chaffing against the engine or airframe. Heat shrink tubing can be used to protect the leads from abrasion, and insulate the electrical connections to the probe.

NOTE : The length of wire on the EGT & CHT probes, or the extension wire may be shortened as desired for your installation.

5.3 Verify the Wiring – A Quick Check

Take a moment now to review all wiring connections you have made to the EIS. Double check the following wiring:

- power
- ground
- tachometer connections
- Verify that the same ground wire is not used as both a ground to the engine for the EIS, and as a ground for the ignition kill switches. Verify that these separate ground leads do not connect to the engine in such a way that they could become disconnected from the engine, but remain connected together. Do not use the same connection to the engine for these ground leads.

Finally, install the connector backshell using the supplied hardware. Secure the wiring, using cable clamps to the aircraft structure so that no strain is transmitted to the connector. Plug the connectors into the EIS and secure them to the instrument with the screws included with the backshell.

6. Check-Out

6.1 Initial Application of Power to the Instrument

Apply power to the system. Verify that the LCD display becomes active. The instrument will be on display page 0. If this operation is not observed, immediately turn off power to the EIS and recheck all wiring—especially power, ground, 4.8V excitation output and 12V fuel flow power output.

At this point, you may wish to completely configure the instrument for your installation. Refer the section “Configuring the EIS for your Installation”.

6.2 Tachometer Initial Test

Turn on the EIS. The tachometer will display 0 when the engine is not operating. Refer to the “Configuration Set Pages” section, and set the TachP/R according to the type of engine you have. Turn off the EIS. Start the engine; turn on the EIS and verify that the tachometer reading is active and appears reasonable.

6.2.1 Testing Tachometer Inputs

Two inputs are provided for the tachometer sensing. The EIS will use tachometer input 1 when a tachometer signal is sensed. If tachometer input #1 is not providing any RPM indication, the EIS will use the tachometer input #2. Each input must be tested to make sure it is functioning. This test is accomplished by turning off tachometer input #1 (such as by turning off the magneto), and observing if tachometer input #2 provides an accurate and stable tachometer reading. Repeat this by turning off the tachometer input #2 and verifying the tachometer input #1 is accurate and stable.

If desired, a combination page can be programmed to display the tachometer reading being sensed by the tachometer input #2. This is accomplished by selecting "N2" to be displayed on a combination page. N2 will always show the RPM calculated from tachometer input #2. The normal "Tach" display will show EITHER tachometer input #1 if it is available, OR tachometer input #2 if it is available.

6.2.2 Testing Tachometer Accuracy

A simple test to help verify the RPM readings are accurate can be made by running the engine at night, and looking through the propeller at a florescent or mercury vapor light. The pulsation of the light will make the propeller to appear to stopped at various RPMs. Verify the propeller appears stopped at the RPMs shown in the following table. Note that this applies to lights powered by 60 Hz electrical power, such as that used in the United States and Canada. Also remember that this is the propeller RPM, and the engine RPM will be higher by the reduction ratio if the engine includes a propeller speed reduction unit.

2-Blade Propeller	3-Blade Propeller
600	240
720	300
1200	480
1440	600
1800	1200
3600	2400

CAUTION : If there is ANY DOUBT that the tachometer is working correctly, use another tachometer that is known good to verify the EIS is giving the correct tachometer reading. Attempting a take-off with an inaccurate tachometer could result in less than full power being available, and this could be very dangerous.

6.3 Other Checks

CAUTION : Verify that no leaks are observed around the coolant temperature sensor (if so equipped), as well as the oil pressure and temperature sensors. Loss of engine oil or coolant will severely damage your engine, and will result in sudden stoppage.

The remainder of the functions should now be checked out by observing the measurements displayed by the EIS. Any measurements that appear unreasonable should be checked to verify their accuracy.

Your EIS is now ready to use. Please refer to the "Before Each Flight" section.

7. Configuring the EIS for your airplane.

Configuring the EIS for your airplane simply involves setting various entries in the "Configuration Set" pages. These settings tell the instrument details about your engine (such as how many pulses per revolution for the tachometer, units, etc.), how the auxiliary inputs are used, the desired units, etc. The best way to set these items is to work your way through the list describing these settings below.

To access the "Configuration Set" pages, press and hold the center and right button until the screen shows "UP DOWN NEXT" on the bottom row. The display will momentarily show the "Set Lean Pt" page while holding these buttons. This is normal. After about 5-10 seconds, the "Configuration Set" pages will be displayed. This

deliberate action is required so that anyone unfamiliar with the instrument will not inadvertently alter the configuration of your instrument.

The settings shown on the “Configuration Set” pages are as follows. The order has been altered by grouping everything related to the auxiliary inputs at the beginning, with the remainder of the settings, in order, following the auxiliary section.

7.1 Setting up your Auxiliary Inputs – Labels and Scaling

You may prefer to wire certain auxiliary functions to particular auxiliary inputs so that they show up together on the labeled page. Aux 1, 2, & 3 are displayed on one labeled page, and Aux 4, 5,& 6 on another. (Of course this data may also be displayed on a programmable page.) After determining this, wire up the auxiliary input as shown on the sheet included with it. Then set the following entries on the configuration set pages.

7.1.1 Aux1, Aux2, Aux3, Aux4, Aux5, Aux6

These pages allow you to define the labels to be used for auxiliary inputs. You may create any label you wish. It may be desirable to use a label with the appropriate number of characters to fit in the space you have defined for it on the combination page.

To change the label, press the left and center button together to enter the “edit” mode. The first character will begin flashing. Use the left and center buttons individually to select the desired character for this position. Use the right button to edit the next character. After editing the last character, the instrument will leave “edit” mode. Pressing the right button when not in edit mode will take you to the next character.

Suggestion! Use 3 character labels for auxiliary inputs configured as integer, since the combination screen will allocate 3 spaces on the screen for auxiliary inputs configured as integers. (Auxiliary inputs configured as decimal numbers will be allocated 4 spaces, making it practical to use 3 or 4 character labels.)

7.1.2 Dual TIT Option and Aux5/Aux6

Instruments that have the dual TIT option can be identified by the "T" in the second letter of the software version, such as "6TS59...". The dual TIT option allows two type K thermocouples probes to provide turbine inlet temperature measurements. These probes are wired to connector A, as shown on figure 5A.

The two TIT inputs are displayed on auxiliary 5 and 6, for TIT1 and TIT2 respectively. While scaling entries (5SF, 5Off, 6SF, and 6Off) are available, these settings are ignored. The labels for auxiliary 5 and 6 may be set as desired, and it is recommended that you set the label for Aux5 to "TIT1" and for Aux6 to "TIT2". The TIT readings may also be displayed on the combination page by selecting Aux5 and Aux6 to display TIT1 and TIT2 respectively.

7.1.3 Auxiliary Scale Factors and Offsets (1SF, 1OFF, 2SF, 2OFF...)

These entries are used to calibrate the auxiliary input so that the value displayed on the instrument has meaningful units and is accurate. Each auxiliary input includes a sheet that tells you the values for the Auxiliary Scale Factor (sometimes abbreviated AuxSF) and the Auxiliary Offset (sometimes abbreviated AuxOff). This instrument uses the labels 1SF & 1OFF for the AuxSF and AuxOff for auxiliary input 1, 2SF & 2 OFF is for auxiliary 2, and so on.

7.1.4 Configuring an Auxiliary Input for a Fluid Temperature Sensor

The auxiliary inputs can be configured to provide accurate readings when connected to a fluid temperature sensor by setting the auxiliary scale factor to a special code of 0. This tells the instrument that the auxiliary input has been wired to a fluid temperature sensor (of the type the instrument has been factor set for, such as type V, or type S as shown on the label on the rear cover). The EIS will then convert the signal on the auxiliary input into a reading in degrees F or C according to the selection on the UNITS page.

The user must install a resistor between the 4.8V output of the instrument, and the auxiliary input used for the fluid temperature, and also connect the fluid temperature sensor to the aux input and ground. The value of the resistor to be used is given in the following table.

Instrument sensor type as shown on the rear cover. This letter will appear in the Software Version.	Value of 1% resistor to connect between 4.8V output and auxiliary input
S	475
V	301

7.1.5 Auxiliary Forward/Reverse Sensing Selection (+/-)

This selection tells the instrument whether each auxiliary input will be sensed forward (increasing voltage = increasing value) or reverse (increasing voltage = decreasing value). The sheet included with the auxiliary input sensor will tell you if forward or reverse is required. In most cases, forward sensing is used.

This page displays all 6 forward/reverse selections on one page. Use the left and center buttons to select the combination that fits your needs. The +/- signs apply, from leftmost to rightmost, auxiliary 1 to auxiliary 6 respectively. The following screen shows auxiliary 2 set to reverse sensing, with all other inputs set to forward sensing.

+	/	-								+	-	+	+	+	+
			U	P		D	O	W	N		N	E	X	T	

7.1.6 Auxiliary Decimal/Integer Selection (D/I)

This selection allows you to choose whether the display includes a decimal point before the last digit (the D selection), or not (the I selection). The decimal selection is useful for displaying such values as Manifold Pressure (inches and tenths of inches of mercury), or possibly fuel level (gallons and tenths of gallons). Integer values are typically used for most auxiliary input functions, including fuel pressure, coolant pressure, ammeter etc. As with the Forward/Reverse sensing function, the leftmost D or I character on the right of the screen applies to auxiliary 1, and the rightmost to auxiliary 6. Use the UP and DOWN buttons to select the desired combination.

7.1.7 Transfer function

The transfer function mathematically defines the relationship between the auxiliary input voltage, and the numeric data displayed on the instrument. This function is of no use to most users, but is provided here for those interested in creating custom applications for the auxiliary inputs.

$$AuxDisplay = (AuxVoltage * AuxScaleFactor / 2.5) + AuxOffset$$

Where the *AuxDisplay* is the value shown on the screen, *AuxVoltage* is 0-5 Volts, the *AuxScaleFactor* is the number entered into the 1SF, 2SF, 3SF or 4SF entry. The *AuxOffset* can be a positive or negative value. Negative values are entered into the corresponding 1Off, 2Off, 3Off or 4Off entry as twice their magnitude – 1. Positive entries are entered as twice their values. Thus, if the desired offset is –5, a value of 9 is entered into the instrument. Similarly, if the desired offset is +8, 16 is entered.

7.2 Units – (Fahrenheit/Celsius and Gallons/Liters)

Three characters are displayed on this page. This first (leftmost) selects the units for the altimeter setting, the next for temperature, and the rightmost character applies to the units used by the fuel flow option.

- To select inches of mercury (the US standard) for the altimeter setting, set the first character to an "I"; for millibars, select "M".
- To select fuel flow units (applies to flow rate & quantity) of U.S. Gallons, select "G"; for Liters select "L" for the middle character.
- To select temperature in units of degrees Fahrenheit, set the third (rightmost) character to "F"; for Celsius select "C".

CAUTION: The limits entered for all temperature data are not changed by this option. Be sure to enter temperature limits in same units as you have chosen for display.

7.3 FC1 & FC2 (Fuel Flow Activation Codes)

For instruments that include the fuel flow option, these entries have no use. For instruments originally ordered without the fuel flow option, these codes are used to activate the fuel flow function, without the need for returning the instrument to the factory for upgrade. In this way, you may easily add the fuel flow option at any time by contacting Grand Rapids Technologies and ordering the fuel flow option. We will supply you with the FC1 & FC2 codes, and a fuel flow sensor.

7.4 FloCal (Fuel Flow Calibration)

This entry allows for fine tuning the accuracy of the fuel flow function. The typical setting for entry is 83 for the "red cube" type flow sensor (180 for the Floscan 201B). To adjust the FloCal entry to maximize the accuracy of the fuel flow function, keep track of the amount of fuel burned by noting the amount of fuel added to the airplane over a period of time (at least 100 gallons), and the amount of fuel used according the fuel flow function. If the amount of fuel used according the fuel flow function is 1% low, increase the FloCal entry by 1%. Similarly, decrease the FloCal entry by the percentage the fuel flow function is over-reporting fuel used.

7.5 FloCalR (Return Fuel Flow Calibration)

This entry adjusts the scaling of the return fuel flow sensor. It is not used unless your fuel system requires monitoring the outgoing and return fuel, using two fuel flow sensors. If only one flow sensor is used, this setting is ignored, and will not affect the fuel flow calculation.

To adjust this setting for dual fuel flow installations, use the following procedure:

1. Set FloCalR to zero.
2. Turn on the electric fuel pump (with the engine not running), and verify a non-zero fuel flow reading is displayed. Increase the value of the FloCalR in steps. As this setting is increased, the displayed fuel flow should drop. Continue to increase this setting until the displayed fuel flow just becomes zero. Use the lowest setting that results in a zero fuel flow display. A typical setting for this entry is 128, but could vary by +/- 30%.
3. After completing this calibration step, this setting will not need to be changed. Adjust only the FloCal (not FloCalR) to calibrate the fuel flow function.

7.6 TachP/R - Setting for Correct Tachometer Readings

The EIS employs a sophisticated method of measuring engine RPM to provide 10 RPM resolution independent of the number of pulses per revolution of the engine. To provide this flexibility, the TachP/R is set to a code corresponding to the number of pulses the instrument detects per revolution of the engine. To set this correctly for your engine, first determine how many pulses per engine revolution will be generated, according to the following paragraphs, and set the TachP/R as indicated by the TachP/R table. (The tachometer can not measure RPM from analog outputs that encode RPM as a voltage level. This type of tachometer output is rare.)

Two inputs are provided to allow sensing the engine RPM from either of two sources. The EIS will use tachometer input 1 when a tachometer signal is sensed. If tachometer input #1 is not providing any RPM indication, the EIS will use tachometer input #2.

Each tachometer input has a corresponding TachP/R setting allowing them to be independently configured. This allows the use of two dissimilar tachometer inputs, such as a magneto and an electronic ignition input. The settings are identified as Tach1P/R and Tach2P/R, corresponding to each of the inputs.

CAUTION: If there is any doubt about the accuracy of the tachometer reading, verify the reading using another tachometer. Attempting to take-off with less than full power can be very dangerous. In general, if the EIS tachometer reading is not erratic, and the TachP/R setting is correct, the tachometer will be accurate to 5 RPM.

7.6.1 Tach Connections to Magneto P-leads, Ignition Coils or Tach Outputs

These types of tachometer connections typically generate one pulse for every, or every other, spark plug fired per revolution of the engine. Thus 4-cylinder engine will have 1 or 2 pulses per revolution, while a 6-cylinder, 4-stroke engine will have 1.5 or 3. If you choose the wrong setting the tachometer reading will be off by half or double the actual RPM. A 27 k Ohm resistor must be connected between the instrument and the mag P-lead as shown in figure 7 to protect the mag from being turned off by a failure in the instrument.

A magneto or ignition test is commonly performed before each flight for airplanes that include dual ignition systems. This test requires turning off each ignition system, and verifying that the engine will function on the remaining ignition system. Two tachometer inputs are provided to allow sensing the engine RPM from either of two ignition systems so that the RPM indication is not lost during the magneto test.. The EIS will use tachometer

input 1 when a tachometer signal is sensed. If tachometer input #1 is not providing any RPM indication, the EIS will use tachometer input #2.

An external switch may also be used to manually select which ignition system provides the tachometer source. Since magneto problems can often be detected early on by erratic tachometer readings, an external switch allows the pilot to choose which magneto is to be monitored, allowing him to choose a different mag on each flight, and thus providing some monitoring of the health of each magneto. A switch can be wired to choose which tachometer output is provide to the EIS tachometer input #1 (as shown on the tachometer wiring diagram), or alternatively, an on/off switch can be wired inline with tachometer input #1. This switch can be opened to force the EIS to use tachometer input #2.

7.6.2 Tach Connections to Lighting Coils (Jabiru, Rotax, and others)

When the tachometer connection is made to the lighting coil, typically 1/2 as many pulses will be generated, as there are poles in the lighting coil. (For 3-phase electrical systems, 1/3 as many pulses as there are poles in the lighting coil.) For CDI-equipped Rotax Engines, 12 magnets are used, generating 6 pulses per revolution of the engine. For non-CDI type Rotax engines, 2 pulses per revolution is generated. Jabiru 4-cylinder engines generate 5 pulses/revolution, and Jabiru 6-cylinder engines generate 4 pulses/revolution.

7.6.3 Rotax 912 Engine

The tachometer output from this engine provides 1 pulse per revolution.

7.6.4 TachP/R Table

Tach P/R Setting*	Pulses per Revolution	Typical Use
0	1.5	6 -cylinder 4-strokes
1	1	4-cylinder 4-strokes
2	2	Rotax 2-cylcle non-cdi
3	3	
5	5	Jabiru 4-cylinder (s/n 22A2662 and older)
6	6	Jabiru 4-cylinder (s/n 22A2663 and newer)
6	6	Jabiru 6-Cylinder
6	6	Rotax 2-cycle CDI
6	6	HKS
7	7	
8	8	
9	9	
10	10	
11	0.5	
12	1.5	
13	2.5	
14	3.5	
15	4.5	
16	5.5	
17	1.25	5-cylinder 4-stroke
18	1.75	7-cylinder 4-stroke
19	2.25	9-cylinder 4-stroke inc. M14 Radial

Larger than 19 not valid.	Don't use TachP/R Settings above 19.	Don't use TachP/R Settings above 19.
---------------------------	--------------------------------------	--------------------------------------

7.7 TachSen

Each tachometer input includes a sensitivity adjustment, identified as Tach1Sen and Tach2Sen on the configuration set pages. The "L" (low) sensitivity setting is best for most tachometer connections as it provides the greatest amount of filtering and tolerance of noise on the tachometer signal from the engine. The "H" (high) sensitivity setting is best for connections to electronic ignition systems that provide a 0-5V pulse output. Since less filtering is provided when the high sensitivity setting is used, it should not be used unless required.

The tachometer input can tolerate signals of 200V or greater, regardless of the TachSen setting.

7.8 Peak – Leaning Function Sensitivity Adjustment

This entry serves as a sensitivity adjustment for the digital leaning functions. For a detailed description of its use, refer to the section “Digital Leaning Page”.

7.9 Max Fuel – (Fuel Capacity Entry for Fuel Flow Option)

This entry is used by the fuel flow function to provide a simple means of resetting the fuel quantity to the airplane's usable fuel capacity. By pressing the left and center button together while on the FUEL set page, it will be set to the entry made on this page.

7.10 Hours (Setting Hourmeter)

This function allows you to set the hour meter so that it matches the actual time on your engine. The hour meter may be set to any value between 0 and 6553.5 hours. The hour meter will advance only when the tachometer is above the TIM-RPM entry. It will reset to zero after 6553.5 hours.

7.11 Tim-RPM (Hourmeter & Flight Timer RPM Threshold)

This entry controls the RPM that will activate the Hourmeter and Flight Timer. While the engine RPM displayed by the EIS is less than the entry on this page, the hourmeter and flight timer will not advance. Setting this entry slightly above the power setting used for taxi will more accurately measure the actual flying time, and will more closely match the tach time. Setting this entry to zero will allow the hourmeter and flight timer to run whenever the engine is running.

7.12 AspdLo, AspdHi, TachLo, TachHi (Landing Checklist Reminder/RPM Range Limit)

These entries can be used to generate a landing checklist reminder, or as an alarm when operating within a restricted RPM band. The landing checklist reminder is especially desirable in aircraft with retractable landing gear, or for those of you like myself that just can't remember to perform a pre-landing checklist. This is an excellent feature, and I encourage you to use it. It's the kind of automation that helps overcome the unreliability of the human pilot.

7.12.1 Landing Checklist Reminder

The landing checklist reminder function will generate an airspeed and/or tachometer warning when the following condition is met.

- The airspeed must exceed the AspdHi setting, and then go below the AspdLo setting. This will generate an airspeed warning (the red warning light will flash, the page will change to the labeled page that includes airspeed, and the airspeed will flash). (Of course, this requires that your instrument includes the airspeed option.)
- The tachometer must exceed the TachHi setting, and then go below the TachLo entry. This will generate an tachometer warning (the red warning light will flash, the page will change to the labeled page that includes tachometer, and the tachometer will flash).

Acknowledging this alarm (by pressing the "Ack" button") results in the following:

- After the warning has been acknowledged, the function is reset, requiring the Hi setting to be again exceeded before the alarm is generated again.
- The warning light will go out when the landing checklist reminder warning is acknowledged.

The recommended setting for AspdLo and TachLo is a setting that is below what you normally encounter in takeoff, climb, cruise, and descent, but above what you encounter when entering the pattern, or while in the pattern. (If you set the "Lo" threshold too low, you may not get the warning until you have already landed, if too high, you may get it long before you are planning on landing.)

The recommended setting for AspdHi and TachHi is a setting that is above what you normally encounter while in the pattern, but reasonably below what you would encounter in takeoff, climb, cruise, or descent. (If you set the Hi threshold too high, you may not ever go above it, preventing a landing checklist warning from being generated, and if you set it too low, you may get the alarm repeated due to power/airspeed changes made while in the pattern.)

You may find some trial and error is necessary to fine tune your settings so your reminder is generated reliably, and not more than once.

An example of the use of this function may best illustrate how to use it. I have found from experience, that based on my flying habits, my RPM does not go below 1900 until I am in beginning my descent in the pattern for landing. I have also noted that while in the pattern, even when making large power changes, my RPM does not go above 2400, although it always goes above 2400 during takeoff. I set my TachLo entry to 1900, and my TachHi entry to 2400. With my flying habits I consistently get an RPM warning (landing checklist reminder really), when I enter the pattern.

Caution : At power-up of the instrument, the checklist function is reset. This means if the instrument is turned off and on again while in-flight, and you do not exceed the "Hi" threshold again, you will not get the warning. Also remember that if something unusual happens (such as partial power loss, staying in the pattern, etc.) , you may not go above your "Hi" threshold, and thus will not get a landing checklist reminder. ***Do not rely solely on the landing checklist reminder function to perform your pre-landing checklist.***

7.12.2 RPM Range Limit

This function is available in software version 5.0 and above, only.

The TachHi, and TachLo settings are also used to specify an RPM range for which an alarm will be generated. When used in this manner, these entries will not function as a checklist reminder.

To use the TachHi and TachLo entries as an RPM range alarm, the TachHi setting must be a lower value than the TachLo setting. When the EIS detects that you have set them in this way, these entries define the RPM range within which it will generate an RPM alarm. For example, if you wish an alarm when the RPM falls between 2000 and 2250 RPM, set TachHi to 2000, and TachLo to 2250.

7.13 AltCor (Calibrating the Altimeter/Barometric Pressure)

To calibrate the altimeter so that the barometric pressure it registers is correct, the follow procedure should be followed. This procedure must be performed with a new instrument, and should be re-checked on an annual basis.

- Turn on the instrument and allow 5 minutes or more for its internal temperatures to stabilize.
- Using the Altimeter Set page, set the altimeter so that the barometric pressure display matches the current altimeter setting. Note that this is the 4 digit number immediately after the ALT label on this set page. No decimal point is provided, so an altimeter setting of 29.92 will be displayed as 2992
- Adjust the ALTCor setting on the configuration set pages so that the altitude display (in feet) matches the local elevation. The nominal value of the ALTCor is 128. Increasing this number by one will change the altimeter display by 6 feet.
- If your ALTCor falls outside the range of 50-200, you may have made a mistake in your calibration.

7.14 AltSF, 1 (10k), 2 (20k), 3 (30k), 4 (40k) Altimeter Adjustments (SW Version 5.8 and above)

These entries are provided to allow precision calibration of the altimeter. To prevent inadvertent alteration of these entries, they can be accessed only by setting the Max Volts limit to 0.2. These entries will appear immediately after the ALTCor setting. To perform the calibration, set the Max Volts limit to 0.2, and follow the "Precision Altimeter Calibration Procedure" in the following section.

7.14.1 Precision Altimeter Calibration Procedure

1. Set the "AltCor" as described above.
2. Connect an air data test set to the airplane. Be sure the pitot connection is secure, as damage to the airspeed pressure sensor could occur if the pitot connection from the air data test set becomes disconnected during this calibration.
3. Set the air data test set altitude to an altitude near the airplane's ceiling. Use the "AltSF" adjustment to correct the displayed altitude so that it matches the altitude selected on the air data test set. Be sure the altimeter (baroset) setting on the test set agrees with that altimeter (baroset) setting in the EFIS.
4. Set the air data test set to an altitude near sea level. Change the "AltCor" to correct the altimeter reading.
5. It may be necessary to repeat steps 3 and 4 a few times, as there are some interactions between these adjustments.
6. Set the air data test set successively to 10,000', 20,000', etc, and use the corresponding altimeter adjustment (1 for the 10,000' adjustment, 2 for the 20,000' adjustment, etc) to make any correction necessary at these altitudes.

7.15 User Definable Combination Pages

7.15.1 1D1, 1P1, ... GD9, GP9

These entries are used to setup your user-definable combination display pages. They are used in pairs (although they appear to 2 successive screens), with the first item of the pair defining the data to be displayed (thus the "D" in the label), and the second item defining the position (thus the "P" in the label) of the item. Two sets of twelve pairs of entries are used to allow up to twelve items to be displayed on each of 2 user-definable combination pages. Nine pairs of entries are provided to allow up to nine items to be displayed on the bar graph pages.

An example of the labels used to identify these page is as follows:

2D1 => 2nd combination page, Displayed item, entry 1
 2P1 => 2nd combination page, Position of item 1, entry 1

Note: The items set up for the graphical leaning pages (that is, the pages with the bar graphs), apply to both of the bar graph pages.

Three or four letter identifiers are used to define the data that can be displayed, and a numeric entry describes the position on the screen where this data appears. In addition to numerical data, several characters may be selected to enhance the readability of your user-defined combination pages. The following table describes these items.

EASY TIP: If you would like to restore the instrument to the factory default setup for the user-definable pages, starting from a normal display page (not a set page) turn off the instrument, and press and hold the right button and turn the EIS back on. This will cause the EIS to restore the factory default settings for these pages.

7.15.2 Table of User-Definable Page Entries.

Data to be Displayed	Name used to select this data on the Configuration Set Page.	Number Of Spaces Required	Notes
Nothing displayed	Off	0	This entry is skipped, and nothing is printed to the screen. Set unused entries to "Off".
EGT1	EG1	4	
EGT2	EG2	4	
EGT3	EG3	4	
EGT4	EG4	4	
EGT5	EG5	4	
EGT6	EG6	4	
CHT1	CH1	3	
CHT2	CH2	3	
CHT3	CH3	3	
CHT4	CH4	3	
CHT5	CH5	3	
CHT6	CH6	3	
AUX5	AX5	3 or 4	User selections allow the data to be displayed as an integer (no decimal point), which requires 3 spaces, or a decimal number which requires 4 digits.
AUX6	AX6	3 or 4	
OILT	OT	3	
OILP	OP	2	
VOLT	Volt	4	
AUX1	AX1	3 or 4	User selections allow the data to be displayed as an integer (no decimal point), which requires 3 spaces, or a decimal number which requires 4 digits.
AUX2	AX2	3 or 4	
AUX3	AX3	3 or 4	
AUX4	AX4	3 or 4	

Coolant Temperature	H2O	3	
Not Used	N/U	-	
Not Used	N/U	-	
UNIT	Int	3	This is the internal instrument temperature
QPH	QP		Factory Use Only
FUEL Flow	Flow	4	
TACH	Tach	4	
Highest CHT	CHH	3	
	CHS		Factory Use Only
CHT Rate	CHR	3	
Highest EGT	EGH	4	
EGT Span	EGS	4	
Highest EGT Change	EGPk	4	Leaning info (EGT or delta from peak EGT) for first cylinder to peak. (FRST2PK indicates which cylinder was first to peak.)
FRST2PK	1P	1	Cylinder number of first to peak while leaning.
ROC	VS	2	Vertical speed magnitude – unsigned. Use the ROCSGN below to display an up or down arrow next to this value to show climb/dive
ROCSGN	+	1	This is the vertical speed sign (an up or down arrow)
Airspeed	ASP	3	Airspeed
Hourmeter	Hours	6	
Fuel Remaining according to the fuel flow calculation.	Fuel	4	
Altitude	Alt	5	
Flight timer hours	Hr	2	Use a : to separate hours and minutes (and seconds)
Flight Timer Minutes	Mn	2	
Flight Timer Seconds	Sc	2	
Fuel Flow Function's Endurance - Hours	EH	2	Use a : to separate hours and minutes.
Fuel Flow Function's Endurance Minutes	EM	2	
Cylinder number with highest CHT	#C	1	This is not the temperature, but which cylinder has the hottest CHT, such as cylinder #2
Cylinder number with highest EGT	#E	1	Cylinder number with highest EGT
Outside Air Temperature	Oat	3	The outside air temperature will be displayed in deg F only.
Carburetor Air Temp	Crb	3	
Barometric Pressure setting for altimeter	Baro	5	
ROCSGN (rate of climb sign - up arrow for climb, down arrow for dive)	+	1	This is the vertical speed sign (an up or down arrow)
Colon symbol	:	1	Allows printing of a : to the screen.
Apostrophe	' (foot symbol)	1	Allows printing of a ' to the screen.
degrees symbol	degrees symbol	1	Allows printing of a degree symbol to the screen.
"/"	/	1	Allows printing of a / to the screen.

The following illustration shows the numbering of positions on the display screen for the user-defined pages. Note how the 32 character positions are numbered from 1-32 starting in the upper left corner.

1	2	3	4	5	6	7	8	9	10	11	12	13	14	15	16
17	18	19	20	21	22	23	24	25	26	27	28	29	30	31	32

7.16 Example Worksheet for setting up your custom pages.

The easiest way to create your custom pages is to plan them on page, and then translate you plan into the entries that you will make in the instrument. To illustrate this, lets create a simple page.

1. Start with a blank worksheet. Fill in typical numbers to illustrate the data you want displayed. Use the table entry of “Number of Spaces Required” to allocate the required space for the items you have selected to display. In this example, the tachometer, oil temperature, oil pressure, altitude and airspeed are displayed as shown.

	1	2	3	4	5	6	7	8	9	10	11	12	13	14	15	16	
Tachometer	2	5	0	0							1	8	0	/	4	5	Oil Temperature/Oil Pressure
Altitude	1	0	5	0	0	'		24	25	26	27	28	29	30	31	32	Airspeed

2. Once satisfied with the layout, create a list of the entries. Use the table above to determine the identifier used by the instrument for each of the items. Fill out the list.

1D1 = TACH

1P1 = 1

1D2 = OT

1P2 = 11

1D3 = /

1P3 = 14

1D4 = OP

1P4 = 15

1D5 = ALT

1P5 = 17

1D6 = '

1P6 = 22

1D7 = ASP

1P7 = 30

1D8 = Off

1P8 = 0

1D9 = AUX1

1P9 = 8

1D10 = Off

1P10 = 0

1D11 = Off

1P11 = 0

1D12 = Off

1P12 = 0

Note that this number corresponds to the start of the data being displayed.

The entries set to “Off” are ignored.

3. Enter these into the instrument’s “Configuration Set” pages.

7.17 Worksheet for Planning User-Definable Pages

1	2	3	4	5	6	7	8	9	10	11	12	13	14	15	16
17	18	19	20	21	22	23	24	25	26	27	28	29	30	31	32

Combo Page #1

1D1 =
 1P1 =
 1D2 =
 1P2 =
 1D3 =
 1P3 =
 1D4 =
 1P4 =
 1D5 =
 1P5 =
 1D6 =
 1P6 =

1D7 =
 1P7 =
 1D8 =
 1P8 =
 1D9 =
 1P9 =
 1D10 =
 1P10 =
 1D11 =
 1P11 =
 1D12 =
 1P12 =

1	2	3	4	5	6	7	8	9	10	11	12	13	14	15	16
17	18	19	20	21	22	23	24	25	26	27	28	29	30	31	32

Combo Page #2

2D1 =
 2P1 =
 2D2 =
 2P2 =
 2D3 =
 2P3 =
 2D4 =
 2P4 =
 2D5 =
 2P5 =
 2D6 =
 2P6 =

2D7 =
 2P7 =
 2D8 =
 2P8 =
 2D9 =
 2P9 =
 2D10 =
 2P10 =
 2D11 =
 2P11 =
 2D12 =
 2P12 =

Bar Graphs use the first 8 character positions.

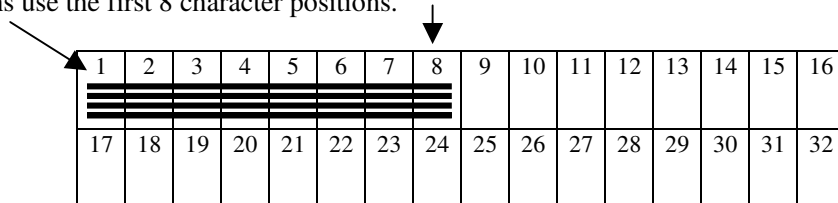

Graphical (Leaning) Pages

Note: Don't assign any items to position 1-8, as this space is reserved for the bar graphs. The setup for this page applies to both bar graph pages.

GD1 =

GP1 =

GD2 =

GP2 =

GD3 =

GP3 =

GD4 =

GP4 =

GD5 =

GP5 =

GD6 =

GP6 =

GD7 =

GP7 =

GD8 =

GP8 =

GD9 =

GP9 =

8. Disabling Pages

Up to 10 display pages may be disabled so that they do not appear when pressing the "Next" and "Previous" buttons. Disabling pages can make it easier to get to the pages that you find the most useful. You may find it useful to disable labeled pages which include information also shown on your programmable combination pages. You may also find it useful to disable the fuel flow page if you do not have the fuel flow option, and/or the altimeter/VSI - Airspeed - Water Temperature page if you do not use these features. Note that the alerting function will not be disabled from using this pages, so that alarms will be annunciated using the appropriate labeled page.

It is recommended that pages are disabled after you have gained some operational experience with the instrument, and after you have settled on the configuration of your user-programmable pages.

To disable a page, determine its page number from figures 1a and 1b. Enter this page number into one of the 10 "Disable Page #" entries which appear immediately after the user-definable page data.

Note: Ten "Disable Pg #" pages are provided. Each of these pages allow one entry. The entry may be either "Off" (indicating this particular "Disable Pg #" page is not disabling any pages), or it may be a number between 0 and 15 corresponding to the page being disabled. The ten "Disable Pg #" pages look identical, with the possible exception of the entry on the page. This gives the appearance that the page is not changing as you page through each of the 10 pages, but in fact there are ten of these pages.

9. Engine Analysis Functions

The engine analysis function includes functions to track your EGTs to detect subtle changes in your engine performance, and functions to help you lean your engine.

9.1 The EGT Tracking Function

Imagine you had a way of watching your engine for the slightest change in its operation for every second of the cruising portion of your flight. Imagine this function was sensitive enough to detect a single spark plug just beginning to foul, or a valve intermittently sticking, or a minute intake manifold leak, or a host of any other problems which could not possibly be detected by the human senses. Imagine the confidence you will feel as you set out over forests, mountains, or a body of water, knowing that your engine has been subject to this scrutiny. This is the real power of the EGT tracking function. Please read on....

The tracking function is normally activated during the cruise portion of the flight. This is because the exhaust gas temperatures will vary with the mixture, power setting, and load on the engine. During the cruise portion of the flight these variables are fixed, making changes in exhaust gas temperature due to engine problems easier to detect. This is especially true during flight in smooth air, where there is no turbulence to cause fluctuations in engine power

To activate this function, call up the "SET LEAN POINT?" prompt by momentarily pressing the center and right buttons. Press the button under the "YES" selection to activate the function. This will store the current exhaust gas temperatures internally, and calculate the change from these temperatures for each cylinder. You will now see a graphical representation of the change in exhaust gas temperature on the EGT Cruise graph, and a digital representation of the change on the page identified with CZ (cruise) identifier. The exhaust gas temperatures stored internally for this function may be updated at any time during the flight by repeating this sequence. (This can be necessary if your cruise conditions change, such as power settings, mixture, etc.). Note that it is not necessary to lean the engine to activate this function.

Separate limits may be set for the increase and decrease in exhaust gas to alert you when any cylinder varies by more than you expect. These are the EGT-INC and EGT-DEC entries on the set pages. These limits may be tight (a few 10's of degrees) to alert you to very subtle changes, possibly at the expense of false alarm in turbulence, or loose (50 degrees or more). Experience will dictate the best settings for your engine/airplane combination.

The tracking function may also be activated during climb or descent if desired. This is especially useful when troubleshooting an intermittent problem. (It may be necessary to re-activate it during this phase of the flight to account for the change in exhaust gas temperatures resulting from the new power setting.)

9.2 Leaning Functions

For those with engines having adjustable mixture controls, the leaning functions are probably what attracted you to the EIS, and you will not be disappointed. The EIS provides a bar graph page for those who prefer this method, and a digital leaning page (identified by an “L” in the lower right corner). It is recommended that you try both methods several times to determine which one is your favorite. In general I prefer the digital leaning pages because they provide finer resolution (1 degree vs. 15 degrees per bar graph segment), but this can be a matter of taste, as the bar graph page can make it easier to visualize the EGTs.

9.2.1 Leaning with the Bar Graph

Using the bar graph page to lean is simply a matter of selecting the page, and adjusting the mixture while observing the EGTs via the bar graphs. You may find it useful to customize the bar graph pages to include information that could make it easier to lean, such as MAP, RPM, Fuel Flow, or the special leaning functions, such as the First-to-Peak and EGPK.

9.2.2 Digital Leaning Page

To understand the digital leaning page, (the page with the “L” in the lower right corner), it is first necessary to understand a few basic rules about the data shown on this page.

- *When a cylinder is close to its highest EGT, the cylinder's EGT is displayed.*
- *When a cylinder's EGT is more than the amount specified on the “PEAK” setting below the highest EGT, a negative value will be displayed showing how far this cylinder's EGT is below its highest.*
- *The highest EGT for a cylinder is continually updated. That is, whenever an EGT goes above the internally stored value for the highest EGT, it is updated.*
- *Selecting the “Save Lean Point?” page, and selecting “RESET”, will reset the highest EGT for each cylinder to its current temperature.*

In light of these rules, the typical procedure for leaning is as follows:

1. Select the digital lean page. This is the page with the “L” in the lower right corner.
2. Select the “Save Lean Point?” window, and select “RESET”. This resets the highest EGTs to the current temperatures. You will note that immediately after doing this, the lean page will show all positive values since all EGTs will be the newly stored highest. This also causes the First-to-Peak indicator to reset to 0.
3. Slowly lean the engine. As you do, the EGTs should all increase (unless you have a cylinder already operating past peak EGT, in which case it will decrease, indicating an engine problem exists). As the EGTs increase, the instrument will be updating its internal highest for each cylinder, and the numbers on the page will show EGTs.

4. As leaning continues, a cylinder will reach its peak EGT, and then begin to fall. Once it has fallen by more than your setting for “PEAK” below its highest, the value shown on the screen will switch to a negative number. The First-to-Peak function will now indicate which cylinder number was the first to peak.
5. Typically the engine is then enriched to 50 degrees rich of peak (although this is a matter of your preference). As you enrich, all EGTs will drop, except those that were leaned past peak. The cylinders which were leaned past peak will first increase, and then decrease. The key to making it simple, it to ignore all but the first to peak (the first to go negative). Use this cylinder to adjust mixture to your desired setting (such as 50 degrees rich of peak).

Note that the leaning page is typically most meaningful while leaning, and for several minutes after leaning. This is because of the effect of the highest EGT always being re-computed. Consider for instance the scenario where you leaned an hour ago, but during the last hour you made some power changes, encountered turbulence, changed altitude, or similarly caused the EGTs to reach new highs. Once re-stabilized in cruise, even if the EGTs returned to the same temperatures they were at immediately after leaning, the new highs for the EGTs stored internally will cause the lean page to show different values than that showed immediately after leaning.

The “PEAK” setting allows you to specify how sensitive the instrument will be to detecting the first cylinder to go past peak. As you lean, an exhaust gas temperature could go down a few degrees during the leaning process due to varying engine loads (turbulence) or other factors. The instrument will not declare a cylinder to be the first to peak unless it is the first cylinder to fall by the amount specified in the “PEAK” setting from the maximum temperature that cylinder has achieved.

9.2.3 Special leaning functions

Two special functions are provided that are helpful when leaning. These functions are selectable on the user-definable pages, and are provided on the factory default bar graph pages.

9.2.4 First-Cylinder-to-Peak (FRST2PK)

This function indicates which cylinder peaked first during leaning. This function will display 0 after selecting “RESET” from the “SAVE LEAN POINT?” page. It will remain as 0 until a cylinder has peaked (fallen by more than the “PEAK” setting from its highest EGT). Once the first cylinder has peaked, this function will show which cylinder was the first to peak. It will not change until “RESET” is selected from the “SAVE LEAN POINT?” page.

9.2.5 EGPK (First-Cylinder-to-Peak Leaning Status)

This function displays the leaning page information for whichever cylinder was the First-to-Peak. The function will display 0 until a cylinder peaks, and then displays either the current exhaust gas temperature for this cylinder if it is currently less than the “PEAK” setting of its maximum EGT, or the number of degrees below the peak EGT detected.

Note that it is perfectly feasible (depending on your leaning preference) to lean the engine using only the EGPK display. Using this display alone, you can lean until the first cylinder peaks, and enrichen (or not) as desired.

9.3 Shock Cooling Detection

The cylinder head rate-of-cooling (in degrees/minute) for the cylinder head temperature that is dropping the fastest is provided by this function. This information is provided on a labeled page above the “CRate” label. A maximum cylinder head rate-of-cooling limit may also be set. Consult your engine manual to see if such a limit is published for your engine. If no limit is published, you may determine a limit by trial and error. While not all agree that shock cooling of the cylinders is a real problem, there is no doubt that internal stresses in the cylinders can be reduced by avoiding shock

cooling. In addition, some of our customers with glider towing operations are convinced that shock cooling can cause cylinder cracking.

10. Detailed Description of Other Functions

10.1 Flight Timer

At power-up of the EIS, the flight timer shows the length of the previous flight in hours and minutes. This makes it easy to recall the last flight time if power is turned off to the instrument before the time is noted. This time will be displayed until 3 minutes into the next flight, at which time it will be replaced with the length of the current flight in hours, minutes and seconds. It is especially useful for measuring the progress on cross country flight since it never forgets to start! For those who forget to wear a watch, and who don't have a clock or a GPS, this timer can be handy for navigation purposes also!

10.2 Unit Temperature

This function is displayed on the hourmeter page, and shows the internal temperature of the instrument. It is used by the instrument for cold-junction compensation of the EGTs and CHTs. It is also useful for estimating the cabin temperature, as it tends to stabilize at about 30-35 degrees F above the ambient temperature.

The unit temperature can also be checked to see if the instrument is being exposed to excessive heat. Unit temperatures above 170 degrees F can degrade the readability of the display. (The display will return to normal when it is cooled to normal temperatures.) Temperatures above 200 deg F can activate the internal thermal fuse, shutting down the instrument.

10.3 H2O (Water Temperature Function)

This function is provided for those using water-cooled engines. It may also be useful for measuring other temperatures in the range of 80-300 degrees F, such as under cowl temperatures, especially for composite airplanes.

11. Updating the EIS Software

EIS Model 4000 instruments with software version 70 or greater (as shown in the software version number on the label, or as might be displayed on the screen at power-up) include field re-programmable memory that allows the instrument to have software updates loaded into it via its serial port.

Software updates can be loaded in the EIS via its serial port from either a loader cable connected to a personal computer, or via any version of the GRT Horizon or Sport EFIS. When loading EIS software via the EFIS, a serial output to the EIS and from the EIS must be connected. Earlier versions of the EIS did not allow for software updates to be loaded into them via the serial port, and thus did not have a serial output connected to the EIS serial input. This connection must be made to allow loading software updates into the EIS.

12. Check Entries Message

The “Check Entries” message will be displayed immediately after power-up if the EIS determines that any user entry (including all limits and all configuration data) was lost or is incomplete. When this message is the EIS will force you to review all entries by taking you to the Set Limits and Configuration Set pages. Carefully review and correct any entries as necessary.

Note: This message will be generated if any user entry is changed, and the instrument is turned off before returning to the normal display pages. This message then serves a reminder that you were in the process of setting user entries when the instrument is last turned off.

If this message appears frequently, this is most likely due to the instrument getting poor quality electrical power. This is most common if the instrument is on while engaging an electric starter, or if it is turned on before the engine is started in airplanes without batteries, or when power or ground connections are loose.

13. Troubleshooting Common Problems

Instrument does not turn on. Warning light is on steady.	Either the instrument is not receiving power, or the 12V or 4.8V output from the instrument is shorted to ground. A simple test is to make a cable with only power and ground wires, and power the instrument via this cable. (This test cable available at no charge.)
Instrument does not turn on. Warning light never comes on.	Open ground connection to instrument, or the voltage provided to the instrument is too low (less than 9V).
One EGT or CHT is erratic.	One of the two wires is unconnected between the instrument and the probe. Most commonly, a crimp connection on the quick disconnect on the probe, or the cable it plugs into, is loose. A visual inspection will usually be enough to find the problem. Another simple test is to use a continuity tester, and verify each pin at the instrument end of the cable has good continuity to the engine case, since each probe is grounded to the engine. The pins numbers are listed on the wiring diagram in the back of this manual.
All EGT and CHT are erratic.	This is caused by an open ground connection to the case of the engine on engines which do not include an electric starter.
Oil Pressure Reads 99 with engine off.	Connection to oil pressure sensor is open circuit. A quick test is to touch the oil pressure lead to ground. This should cause the oil pressure to read 0. If it does, check connections and ground to oil pressure sensor (case must be grounded.) If this test does not cause a 0 reading, check the connection between this wire and the input to the instrument.
Oil or Coolant Temperature shows 59 deg F all the time.	The connection to the oil or coolant temperature probe is open, or not grounded. A quick test is to touch the coolant temperature sensor lead to ground. If the EIS show a high temperature, the connection to the instrument is good. If it does not change, check the wire between the instrument, and the oil or coolant temperature sensor, especially the crimp on the quick-disconnect that plugs onto the coolant temperature sensor.
Tach Reading is zero when one mag is turned off.	This is normal, as the tach signal is generated by one of the mags.
Tach is erratic.	Tachometer resistor is not installed, or its value is too low. See wiring diagram for tachometer connection.
Tach reading is steady, but too low or too high.	TachP/R is incorrectly set. See "Configuration Set Pages" section.
Voltmeter reads to high. All else OK.	An "update" version of software has been installed, and the setting on the Units page (the H/N setting) is incorrect.
Voltmeter reads above 20 V and other readings incorrect.	More than 5 volts is being applied to an auxiliary input. This can be caused by an incorrectly calibrated capacitance fuel fuel probe, a open ground wire to the manifold pressure sensor, or similar. Check the aux inputs be see if any are above 5 volts using a voltmeter.

14. Warranty

Grand Rapids Technologies Incorporated warrants this instrument to be free of defects in material and workmanship for 2 years from the date the system is first used, or 5 years from date of purchase. This warranty includes parts and labor. The instrument includes a lifetime warranty for any manufacturing defects. Grand Rapids Technologies expressly reserves the right to repair or replace a defective unit with new or reconditioned parts or equipment, of the same or similar design. This warranty is void if damage to the instrument is caused by incorrect connection of the tachometer lead, or is otherwise installed incorrectly. This warranty also does not cover the following:

- Damage during shipment
- Damage from accident, misuse, negligence, lightning, or water
- Damage caused by alteration or unauthorized repair

Legal Rights/Limitations of Liability

Grand Rapids Technologies Incorporated is not liable for incidental or consequential damage, commercial loss, or any other loss or damage not specified in this warranty. Some states do not allow limitations on the length of implied warranties, or exclusion or limitation of incidental or consequential damages. The above limitations or exclusions may not apply to you. No individual or company may extend this warranty. This warranty is valid only for the original purchaser.

Service may be obtained by returning the instrument to this address:

Grand Rapids Technologies
3133 Madison Ave SE
Grand Rapids, MI 49548
Attention: Service Dept.

When returning the instrument for service, please specify the nature of the problem. Include a copy of your proof of purchase for warranty repairs.

For service questions or repair rates, call 616-245-7700.

15. Figures

Figures for the EIS, and the most common uses of the auxiliary inputs, are included here. See the website for more uses of the auxiliary input.

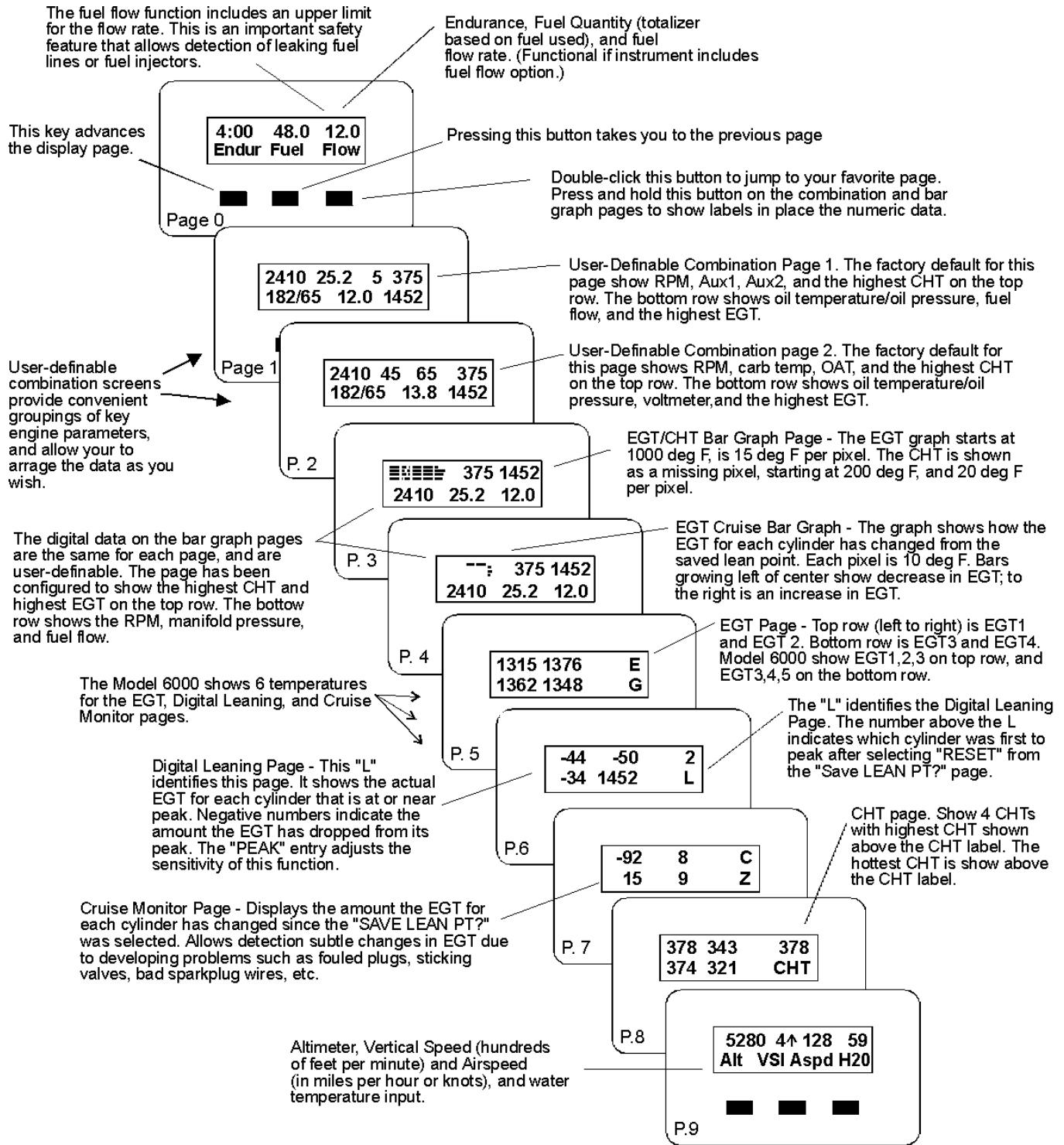
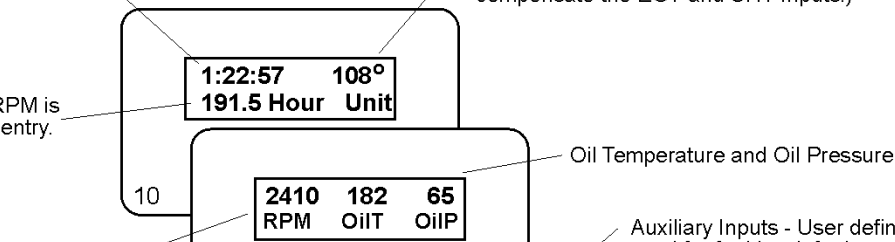

Figure 1a. Model 4000 and 6000 Display Pages

The flight timer runs when the RPM is above the TIM-RPM entry. It shows the last flight time at power-up, and until 3 minutes into the next flight. This timer shows hours:minutes:seconds.

Internal Instrument Temperature (Used by the EIS to temperature compensate the EGT and CHT Inputs.)

Engine Hours - Accumulates when RPM is above the TIM-RPM entry.



Oil Temperature and Oil Pressure

Tachometer

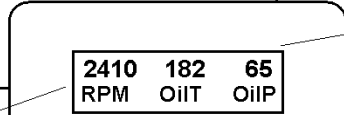

Auxiliary Inputs - User definable inputs that may be used for fuel level, fuel pressure, manifold pressure, coolant pressure or a variety of other uses. The scaling and labels are user-selectable, allowing you to change the AX1 label to MAP for instance.

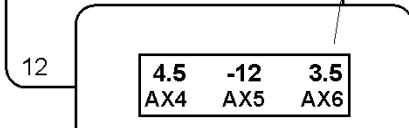
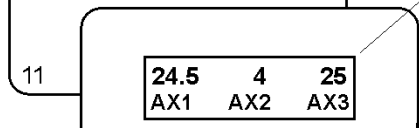

Outside Air Temperature and Voltmeter

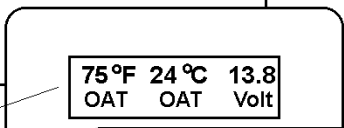

Carb Temperature

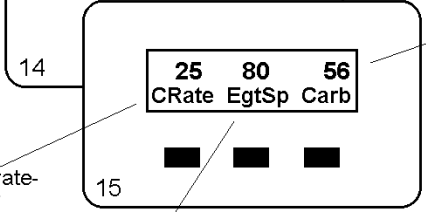

Cylinder Head Rate-of-Cooling - Shows the rate-of-cooling (in degrees/minute) of the cylinder head temp which is cooling the most rapidly. Allows for detection of shock cooling.

EGT Span - This shows the difference between the hottest and coolest EGT. It is especially useful to help characterize your engine, allowing easy detection unusual EGT readings.

A flashing light will alert you to a new alarm. At the same time the EIS will automatically switch to a labeled page, and will flash the offending item to clearly identify the problem.

If the pilot's corrective action solves the problem, the warning light will stop flashing, and the instrument will return to the page it was previously on.

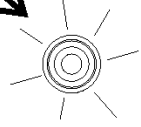
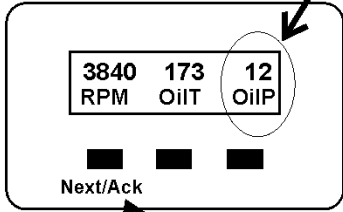

Annunciation of Alarms

By far, this is the most important function of the EIS. Without alarms, it is the engine that alerts the pilot.

Note how the warning light makes the alarm obvious, and the labeled page and blinking display clearly identify the problem so that the proper

If the problem can not be solved, the pilot acknowledges the alarm with the Next/Ack (acknowledge) button. The warning light will stop flashing, but will remain illuminated until the problem goes away. The display page will return to the page it was previously on after the alarm is acknowledged.

Figure 1b. Model 4000 and 6000 Display Pages

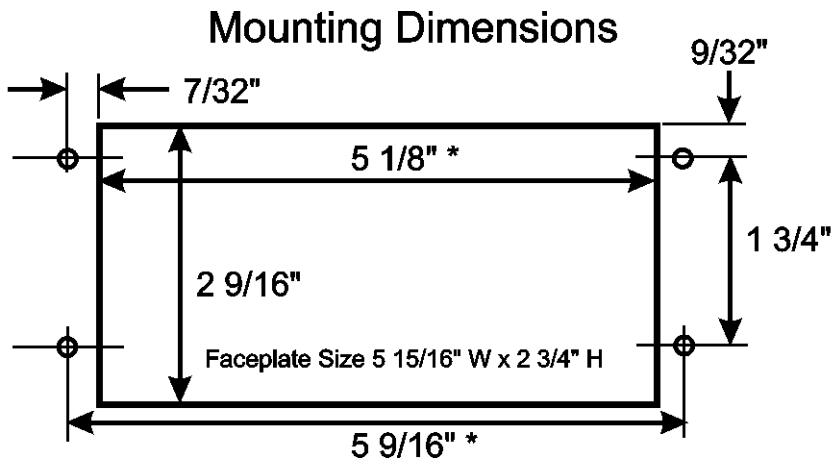

Note: Instruments are 2 3/8" deep. Allow 3/4"-1 1/2" additional depth for connectors on rear of instrument. The warning light requires a 19/32" diameter mounting hole.

Figure 4. Mounting Dimensions

When two tach sources are available (such as one from each of 2 mags), wire one to each tach input. The EIS will use tach 1 if it is providing a signal, otherwise it will use tach 2.

4.8V Sensor Excitation Output
May be needed for some uses off the auxiliary inputs.

Tachometer - Input 2
Active for SW versions 75 and above. SW Version will appear on screen at power up if the instrument supports dual tach inputs. (See Figure 7 for this connection.)

Tachometer - Input 1
(See Figure 7 for this connection.)

+12V Regulated Power connect to red wire of FloScan Model 201B flow sensor.

Fuel Flow Return
Connects to white wire of Model 201B flow sensor. (Dual Fuel Flow Option Only)

Serial Out

Serial In

Aux 4

Carb Temp

Power & Voltmeter

N.C.

N.C.

Audio Out (to intercom)

Red/Blue

Black

4.8V Excitation Output

Blue

Ground

Yellow-Gray

Green

Gray

Orange

Brown

Red/White

Orange/Black

Gray/Black

Gray/Red

White

White/Green

Black

White

White/Green

Black

White/Green

Black

White/Green

Black

White/Green

Black

White/Green

Black

White/Green

Black

White/Green

Black

White/Green

Black

White/Green

Black

White/Green

Black

White/Green

Black

White/Green

Black

White/Green

Black

White/Green

Black

White/Green

Black

White/Green

Black

White/Green

Black

White/Green

Black

White/Green

Black

White/Green

Black

White/Green

Black

White/Green

Black

White/Green

Black

White/Green

Black

White/Green

Black

White/Green

Black

White/Green

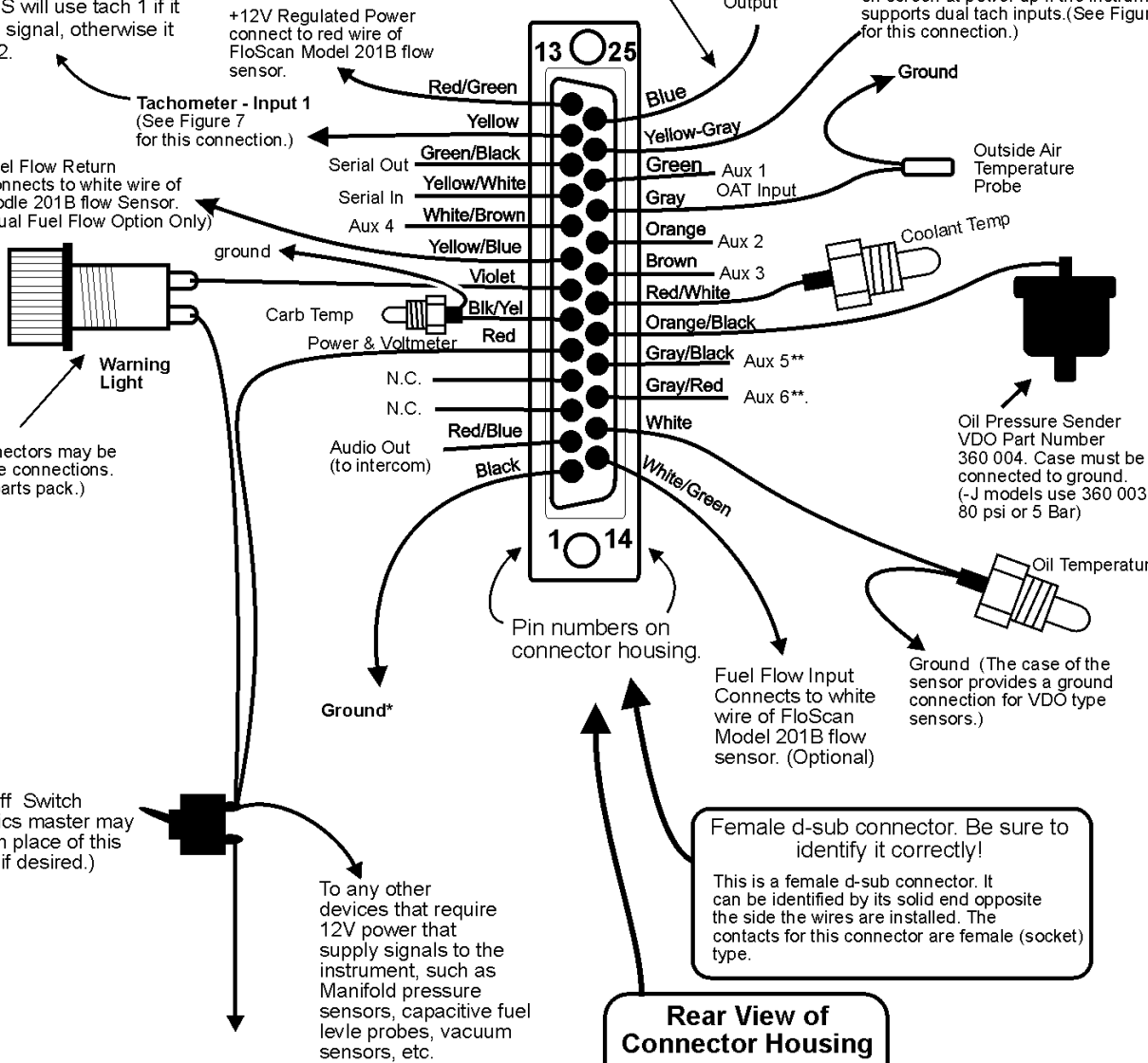

Push on connectors may be used for these connections. (Included in parts pack.)

On/Off Switch
(The avionics master may be used in place of this switch if desired.)

Ground*

To any other devices that require 12V power that supply signals to the instrument, such as Manifold pressure sensors, capacitive fuel level probes, vacuum sensors, etc.

Female d-sub connector. Be sure to identify it correctly!
This is a female d-sub connector. It can be identified by its solid end opposite the side the wires are installed. The contacts for this connector are female (socket) type.

Rear View of Connector Housing
This view shows the side of the connector housing that the wire are inserted into.

**Aircraft Power
10.5-28 Vdc**

Note: Instrument includes an internal thermal fuse for internal protection. Any fuse 5 Amps or less to protect wiring to the instrument is sufficient.

Notes:

* See the "Installation" section, "Wiring" sub-section of the manual for notes regarding proper grounding.

N.C. indicates No Connection. Do not wire to these inputs. They are reserved for future growth.

**Aux5 and Aux6 apply only to instruments with software versions xxx46, or instrument labeled as 6 Aux Inputs. For all others, these inputs should be unconnected.

Figure 5a -- Connector A Wiring for Model 4000/6000/9000

fig5ab16.dual tach input Rev A.cdr

Yellow Wires for EGT Connections on this side.
 White wires for CHT connections on this side.

Red Wires on this side of connector

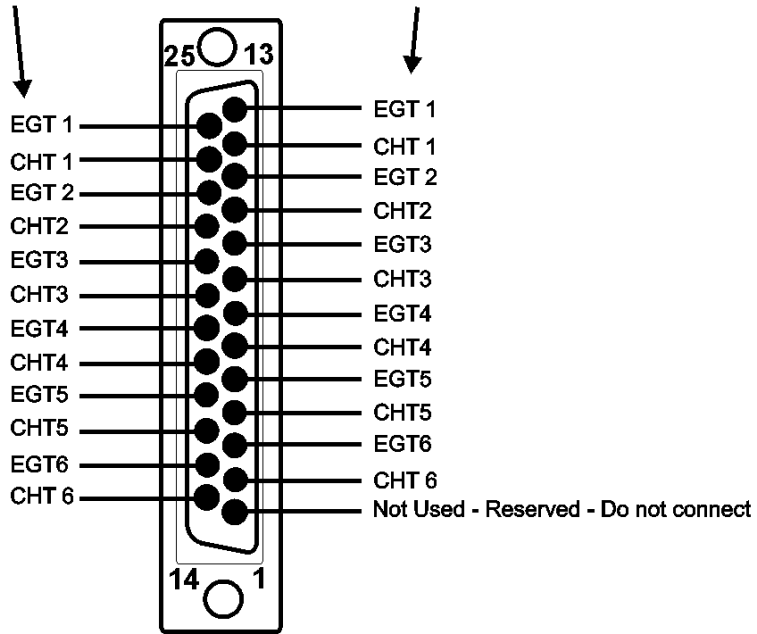

Mark these wire pairs using this diagram before you install the cable!

Our favorite method is to first cut the ends of the wire at different angles. (Keep notes so you don't forget what the cuts mean!) Other methods of labeling the wires, such as tags or ink, may come off when the wires are routed (pulled) through the firewall.

After the wires are routed through the firewall, water-proof tags may be used.

Rear View of Connector Housing
 This view shows the side of the connector housing that the wire are inserted into.

Male d-sub connector. Be sure to identify it correctly!
 This is a male d-sub connector. It can be identified by its hollow end opposite the side the wires are installed. The contacts for this connector are male pins.

Notes:

Type K thermocouple extension wire must be used for EGT connections, and type J thermocouple wire must be used for CHT connections when the External Cold-Junction input is not used.
 For Model 4000 versions, EGT5, EGT6, CHT5 & CHT6 are not used.

fig5bb16.cdr
 rev A

Figure 5b -- Connector B Wiring

Rotax (Tympanium) Regulator/Rectifiers -- (Also applies to Jabiru, HKS, and most others not otherwise listed.) Only one of the two inputs to the regulator/rectifier will give a good tachometer reading. The incorrect lead will give a tachometer reading that decreases with engine rpm. The correct lead must be determined by trial and error.

The small Tympanium regulator rectifier (identified by its 2 yellow, 1 red and 1 black wires) often overcharges batteries. If your battery voltage exceeds 15 volts while using this regulator/rectifier, your

Making the tachometer connection is dependant on the type of

Key West Regulator/Rectifier. The gray tachometer lead must be used. The lighting coil wires may not be used as a tachometer source with this regulator/rectifier.

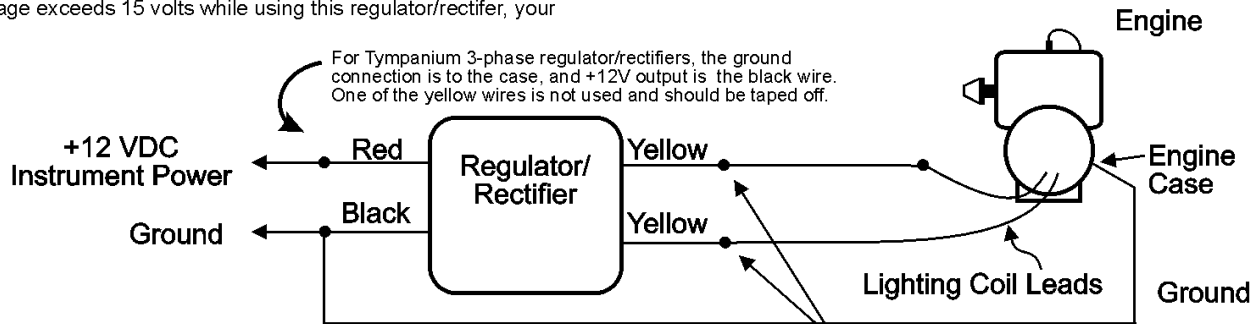

Rotax 2-Stroke Engines : The gray tach lead may be used for tachometer connections. The only drawback to this method is that the tach reading might (not always) go to zero when turning off one mag during the mag check, specially if the mag check is performed at low (less than 3000) RPM. . If a battery is used, tachometer connection may be made to the lighting coil as shown above to avoid loss of the tach reading during the mag check.

Connect the tachometer input of the EIS to either on of these lighting coil leads.

Figure 7a. Tachometer Connections to Lighting Coil Equipped Engines (Rotax, Jabiru, Hirth, Zenoah, etc.)

Electronic Ignition

Connect directly to the tach output from the ignition system. No resistor required.

Rotax 912/914

Connect tach input to one of the two tachometer output wires. Connect the other tach output wire to ground.

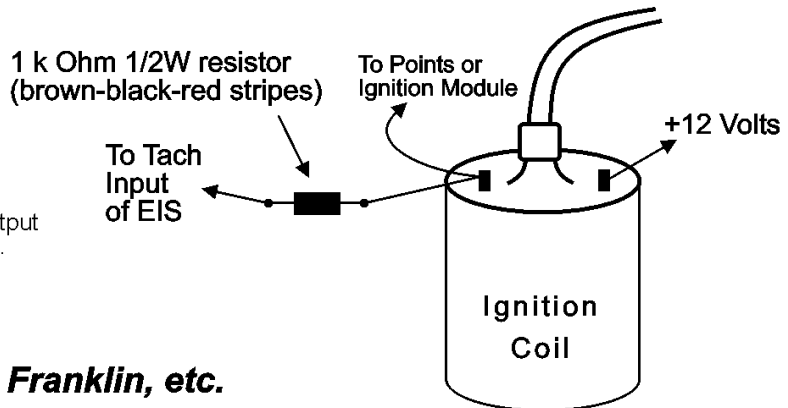

Magneto Equipped Engines such as Lycoming/Continental, Franklin, etc.

39 k Ohm 1/2W resistor (orange-white-orange stripes) or 27 k Ohm 1/2W resistor (red-violet-orange stripes) (This resistor is Included in parts pack - it is covered with black heat shrink tubing and has male and female quick-disconnects)

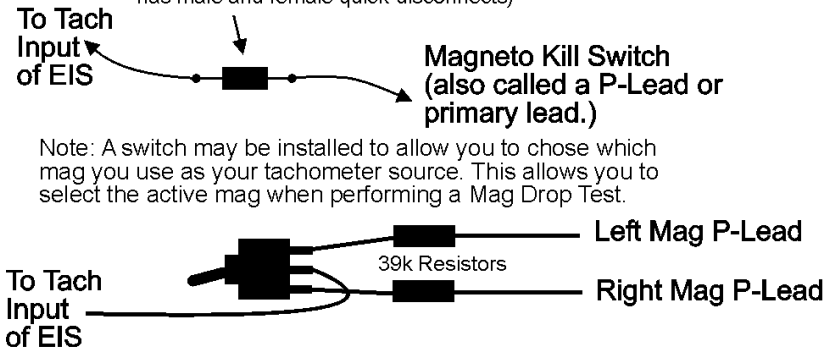

Note: A switch may be installed to allow you to chose which mag you use as your tachometer source. This allows you to select the active mag when performing a Mag Drop Test.

Point-Type Ignition

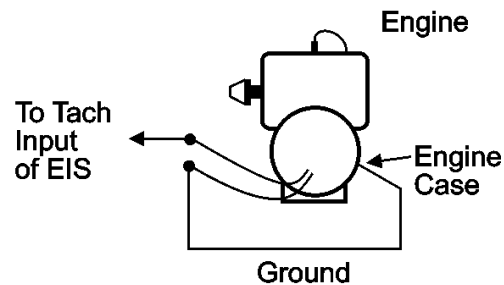

Spare Lighting Coil

Figure 7b. Other Tachometer Connections (Model 2000/4000/6000 EIS)

tach.cdr Rev C

Fuel Flow Option - Installation and Calibration of the Floscan 201B or EI FT-60 Fuel Flow Sensor

Installation

Turbulence in the fuel line caused by valves or sharp elbows mounted close to the flow sensors inlet or outlet will cause erratic readings and reduces accuracy. The sensor should be installed with at least 5 inches of straight or gently curving fuel line providing fuel to the sensor. The fuel line exiting the flow sensor should be routed level with, or above the flow sensor, and should be at least 1-2 inches long before the first valve, elbow, or other turbulence producing device. A gascolator or filter should be installed upstream of the flow sensor to filter out debris which could affect sensor operation. The vapor venting design of the sensor requires that it be positioned with the electrical wires pointing up. Max operating pressure is 100 psi.

The sensor should be retained with two 1/4" bolts through the mounting hole provided. Fuel line connections are made via the 1/4" FPT threaded inlet and outlet. Do not exceed a torque of 25 ft-lbs. Be sure to install the sensor such that the fuel enters the port on the sensor marked "IN".

For dual fuel flow sensor versions of the EIS, a second flow sensor is installed in the fuel line which returns fuel from the engine, back to the tank.

The flow sensor has been designed so that should the internal rotor become blocked, fuel will continue to flow without a significant increase in pressure drop across the sensor.

After completion of your fuel system, be sure to verify adequate fuel flow according to current regulatory requirements. (Typically a minimum flow rate of 125-150% of full throttle fuel flow is typically required.) The EI Model FT-60 sensor will cause a pressure drop of 0.06 psi at 10 gallons/hour, 0.14 psi at 15 gallons per hour, 0.57 psi at 30 gallons/hour, and reaches 2.3 psi at 60 gallons/hour. The FloScan model 201B sensor will cause a pressure drop of 0.13 psi at 10 gallons/hour, 0.3 psi at 15 gallons per hour, 1.2 psi at 30 gallons/hour, and reaches 4.8 psi at 60 gallons/hour.

Wiring

The three wires connecting to flow sensor to the EIS are color-coded. Two of the wires from the flow sensor connect to inputs of the EIS. These are the red and white wires. Connect the flow sensor's red wire to the instrument's +12V Fuel Flow Power. Connect the flow sensor's white wire to the instrument's Fuel Flow input. The black (ground) wire should be connected to any convenient source of ground. 20 or 22 gauge stranded wire should be used for these connections. No fuse is required. A connector of your choice can be used if desired.

Important!
Follow these instructions!

Calibration

Calibration can be performed according to the following procedure to increase the accuracy of the system for your particular installation. Calibration is a controlled via the FloCal entry on the configuration set pages. These pages are accessed by pressing and holding the center and right button for 3 seconds. The right button is used to advance to the FloCal entry.

The nominal entry for the FloCal entry is 83 for the EI-FT-60, and about 160 for the Floscan 201B. This setting should be used until initially.

After your fuel system has been verified to be functional and free of any leaks, the following procedure can be used to maximize the accuracy of the fuel flow function.

Starting with the aircraft filled to capacity (or some other accurately repeatable quantity), enter this amount into the EIS fuel quantity setting. Each time a fuel is added to the aircraft, use a log as shown in the example below.

At the completion of the calibration period, fill the aircraft to capacity (or whatever quantity you started with). Use the log to calculate the actual total quantity of fuel used during the calibration period, and the total fuel recorded as used by the totalizer (by adding up the column "Totalizer Change"). In this example the fuel flow system is reading slightly high. Now compute the new FloCal setting by taking the current setting (for example, 83) multiplying by the actual fuel used (46.4) and dividing the result by the sum of the totalizer changes (47.4). Reset the FloCal to this value, in this example 81. Calibration is complete, but this log may be continued until you have achieved the desired accuracy.

Pulsation Dampener

A pulsation dampener may be required if the fuel flow readings are erratic, or if they read higher when an electric fuel pump is turned on. This is mostly likely when the fuel system is composed of mostly metal fuel lines, and there is no trapped air in the system. A pulsation dampener can be fashioned by installing a tee in the fuel line between the electric fuel pump, and the flow sensor, and connecting a 1 or 2 foot piece of tubing to this tee, oriented vertically up. Cap the end of this tubing to trap air in this line. Most often no provision is required for a pulsation dampener, as the fuel line leading to the fuel pressure sensor traps air and performs this function.

Starting Fuel Onboard 20.0 Starting Totalizer 20.0

Fuel Added	Totalizer Reading	Totalizer Change	Totalizer Set to:
8.5	11.3	8.7	20.0
5.4	10.5	9.5	15.9
9.0	10.3	5.6	20.0
5.3	14.3	5.7	20.0
2.9	5.3	14.7	8.2
15.3	5.0	3.2	20.0

tank filled
partial fueling
tank filled
tank filled
partial fueling
tank filled

Ending Fuel Onboard 20.0

Total Fuel Added 46.4 Sum of Totalizer Changes 47.4

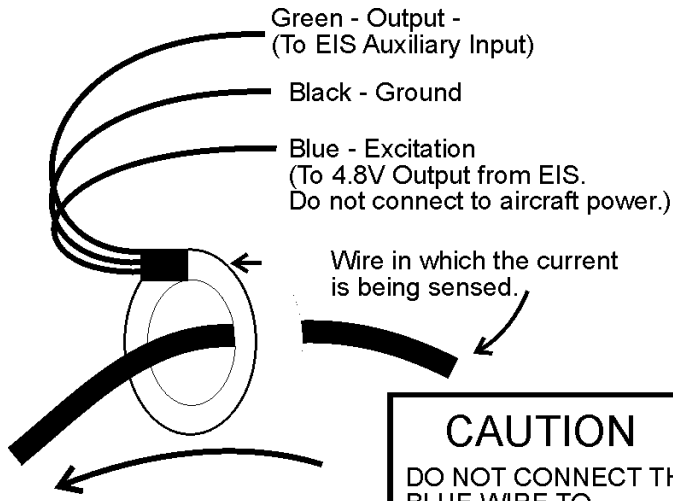

The EIS will register positive current flow when the current is traveling this direction.

CAUTION
DO NOT CONNECT THE BLUE WIRE TO AIRCRAFT POWER. This will destroy the sensor. This damage is not covered warranty.

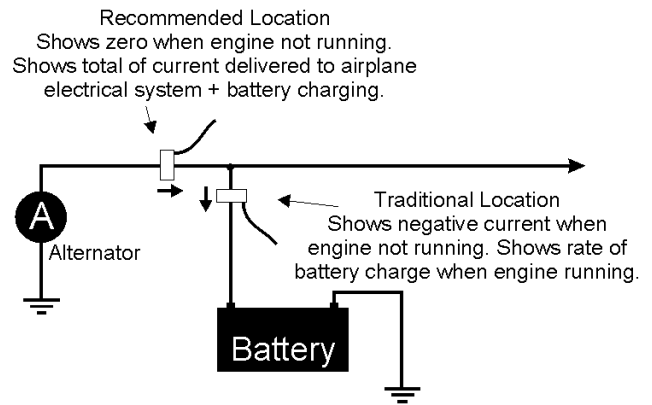

The recommended location shows the current output from the alternator. Since the battery typically recharges rapidly after startup, this location will show the current being consumed the airplane's electrical system. An abnormally high reading indicates the battery was significantly discharged, or something in the airplane is consuming an unusually high amount of electrical current.

The Hall Effect current sensor measures the current flow in the wire that passes through it, without any electrical connection to this wire. Two locations for mounting the sensor are commonly used.

Sensing Battery Current: Mounting the sensor such that the battery positive cable is passing through the sensor will show the amount of charge or discharge of the battery. A negative current indication indicates the battery is being discharged. A positive indication indicates the rate of charge. (The sensor may also be installed in the ground lead, with the arrow on the sensor pointing away from the battery.)

Sensing Alternator Output: Mounting the sensor such that the alternator output cable passes through the sensor will show the amount of current being supplied by the alternator. This will always result in a positive current flow, since current will normally not flow backward into the alternator.

The sensor may be mounted on the engine side of the firewall, or the cabin side.

For sensing current in the -100 to 100 Amp range, or -50 to +50 Amp range, an auxiliary input which does not include a decimal point in the display is the best choice, as the displayed value will have a resolution of 1 Amp.

For Sensing -100 to +100 Amps: (See note 1 below.)

- Set the Forward/Reverse Sensing to FORWARD
- Set the Auxiliary Scale Factor to 164.
- Set the Auxiliary Offset to 313.

For Sensing -50 to +50 Amps: (See note 1 below.)

- Set the Forward/Reverse Sensing to FORWARD
- Set the Auxiliary Scale Factor to 82.
- Set the Auxiliary Offset to 155.

Loop the wire which carries the current being sensed through the sensor so that it passes through it 2 times.

For Sensing -10.0 to +10.0 Amps:

Use the settings for -100 to +100 amps, but loop the wire which carries the current being sensed through the sensor 10 times. The display will indicate 1/10s of an Amp, making this arrangement best suited for an auxiliary input which includes a decimal point.

For Sensing +/- 25.0 or +/- 25 Amps . Use 4 turns of wire through the current sensor, and set the AuxSF to 410 and AuxOff to 783 to display current with 0.1 amp resolution (you will want a decimal point in the aux display for this). With these settings, the current display may be somewhat noisy (erratic) If you prefer to show the current with a resolution of 1 amp , use and AuxSF of 41, and an offset of 77.

Notes

1. To display negative values an/or to enter auxiliary offset values greater than 256 into the EIS, a software version of 45 or greater is required. For software versions prior to 45, the -50 to +50 Amp range may be used, and only positive currents may be sensed. Alternatively, The aux offset may be set to 157 for the 100 Amp range, or 77 for the 50 Amp range. This will result in 0 current being displayed as 100, positive current as values greater than 100 (for example, 125 would correspond to +25 Amps), and negative values as values below 100 (for example, 75 would correspond to -25 Amps.)
2. The Auxiliary Offset may be adjusted if necessary to zero the reading by adjusting it up or down by 2 counts a time. (The aux offset value must remain an odd number, and only a small change should be required, if any.)

Hall Effect Current Sensor

The manifold pressure sensor measurement is typically made via one of the primer ports on the intake manifold. While this means one cylinder does not get primed for starting, this does not affect starting the engine. A fitting and a copper line (the same type used for the primer) runs from the engine, through a bulkhead fitting on the firewall. On the cockpit side of the firewall the tubing can transition to silicone rubber tubing. This connects to the MAP sensor as shown.

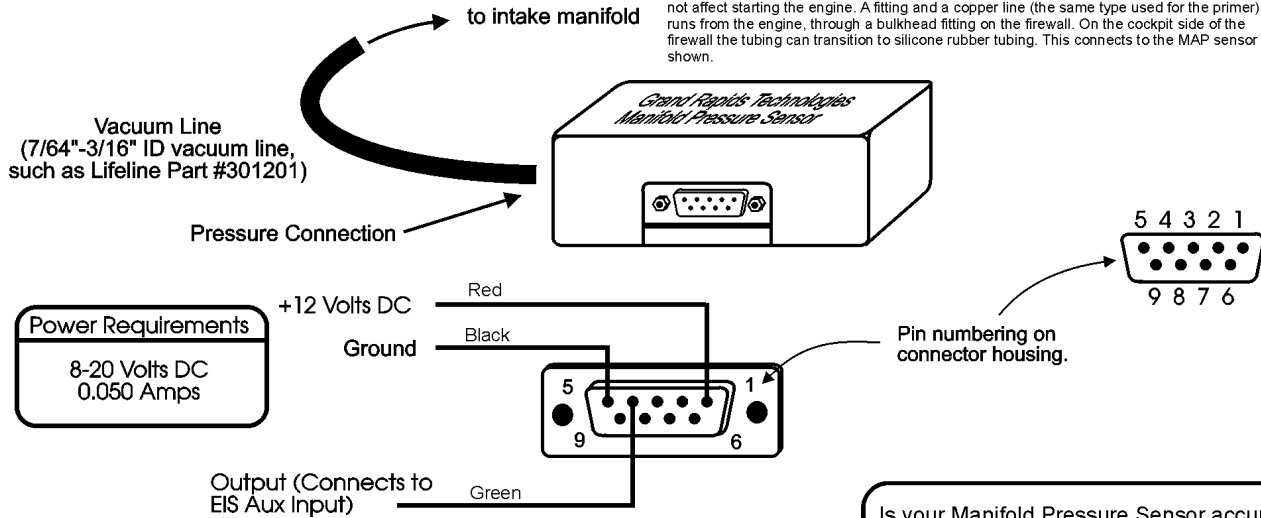

Notes:

1. Mount the Adapter to avoid water, fuel, and extreme heat. The sensor should not be mounted in the engine compartment.
2. Turn off power to the adapter when not in use to avoid discharging the aircraft's battery.
3. Set the Auxiliary Scale Factor and Offset (AuxSF and AuxOff) as shown on label of sensor. These numbers are entered into the EIS on the configuration set pages, and are identified on these pages as AuxNSF and AuxNOff, or NSF and NOff, where N is a number identifying which auxiliary input it applies to. (For example, if the MAP sensor is wired to Auxiliary input 1, you will need to set Aux1SF and Aux1Off, or 1SF and 1Off, to the values shown on the label of the MAP Sensor.
4. In some cases, depending on the engine, and many other variables, the manifold pressure display may fluctuate up and down as much as an inch of mercury. This can be eliminated by installing an orifice with a hole drilled by a #70 bit in the manifold pressure vacuum line near the engine. This restriction provides a filtering effect, and prevents an air leak if the vacuum line was to fail any place after the orifice.
5. With the engine not running, the instrument will show a pressure reading equal to the altimeter setting less the 1" of mercury for every 1000 feet above sea level. For example, if the altimeter setting is 29.70, and your airport has an elevation of 700 feet, the correct reading for manifold pressure will be 29.0 with the engine not running.
6. The MAP-02 includes an Auxiliary Scale Factor and Offset for both a 2 digit reading (for displaying the pressure with a 1" of mercury resolution), and a 3 digit reading (for displaying manifold pressure with a 0.1" Hg resolution).

Is your Manifold Pressure Sensor accurate?
 The manifold pressure reading will not be equal to the altimeter setting unless you are at sea level. See note 5 to determine the correct reading based on your field elevation and the current altimeter setting!

Manifold Pressure Sensor

Grand Rapids Technologies, Inc

MANPRES.cdr
 07/2012

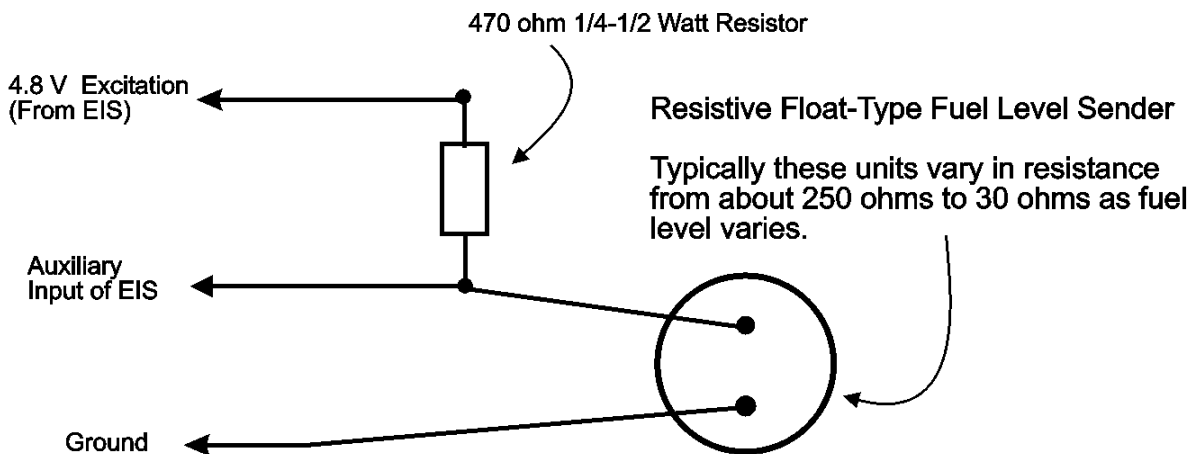

The following steps may be used to calibrate the aux display so that it displays fuel level in gallons, or any desired units.

Decide if you would like to display fuel with a resolution of 0.1 (decimal), or 1 (integer). For Model 2000 instruments, the auxiliary input is pre-set to 0.1 (decimal) or 1 (integer) resolution. Model 4000/6000/9000 can be user-configured using the I/D entry (integer/decimal) on the configuration set pages. Generally we recommend using a resolution of 1.

1. Start by setting AuxSF to 100, and AuxOff to 0, and the Aux Forward/Reverse to Forward (On the Configuration Set Pages). The Aux display should now read a value other than zero. If it still reads zero, check your wiring. It is suggested the following step be performed with the airplane in its flight attitude.

2. Write the Empty tank reading displayed on the EIS here _____
 When draining fuel from the tank, the EIS auxiliary display may stop changing before the tank is empty. You may wish to note the amount of fuel remaining in the tank when the reading stops changing, as this fuel will not be sensed by the fuel level sensor, and in effect will be reserve fuel (that is, fuel remaining when the fuel level readin shows empty.)

3. Write the Full tank reading displayed on the EIS here _____
 Note: As fuel is added to the tank, the EIS auxiliary display will change. Once the sending unit reaches its limit of travel, the reading will stop changing, even as more fuel is added. Note the amount of fuel in the tank when the reading stops changing, as this may be useful in step 6.

4. If the full tank reading is less than the empty tank reading, set the auxiliary Forward/Reverse selection to Reverse, and repeat steps 2 and 3.

5. Subtract the Empty Tank Reading from the Full Tank Reading. Enter the difference here. _____

6. Write down the reading you want to see when the tank is full. _____
 Note that in many tanks, the sending unit will reach its maximum travel before the tank is full of fuel. If this is the case with your tank, we recommend using this as your full tank reading. For example, if you note that the auxiliary display stops changing after 12 gallons of fuel is added to a 15 gallon tank, we suggest you use 12 gallons as your full tank reading. When more than 12 gallons of fuel is in the tank, the EIS will display 12, but this typically provides more accurate readings below 12 gallons, where accuracy is most desirable.

7. Divide line 6 by line 5 (line 6/line 5) _____

8. Multiply line 7 times 100. Round this to the nearest whole number. This is the AuxSF you will enter _____

9. Multiply line 2 times line 7. If your auxiliary input being used to display fuel level includes a decimal point in the display, then multiply this result by 10. Write down the result, rounding it to the nearest whole number. _____

10. Multiply line 9 by 2. _____

11. Subtract 1 from line 10. This is the AuxOff _____ (This must be an odd number)

○ CAUTION: Be sure to connect the resistor as shown. Connecting power directly to the sensor will damage it.

Use of Float-type Variable Resistive Fuel Level Sender with EIS Auxiliary Input

Grand Rapids Technologies, Inc.

FloatFL.CDR